

SOUNDPROOFING SOLUTIONS

TIMBER, STEEL AND MASONRY STRUCTURES

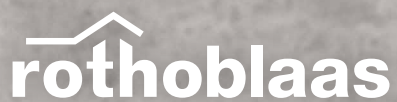

**rothoblaas**

Solutions for Building Technology

IMPACT NOISE

Noise generated by mechanical excitation of an intermediate slab (e.g. footsteps or moving furniture in a flat).

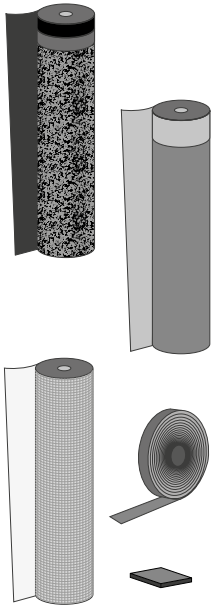

SILENT FLOOR PUR.....	28
SILENT FLOOR TEX.....	32
SILENT FLOOR BYTUM.....	34
SILENT FLOOR PE.....	36
SILENT FLOOR NET 3D.....	38
SILENT EDGE	40
SILENT STEP.....	45
SILENT STEP ALU	46
PIANO A	47
SILENT UNDERFLOOR.....	48
GRANULO.....	49

from page
21

AIRBORNE NOISE

Noise that can be transmitted through the air (e.g. music or conversations).

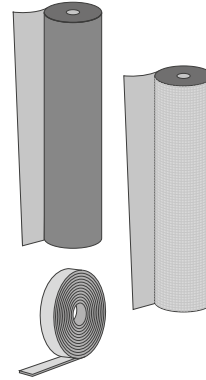

SILENT WALL BYTUM SA.....	60
SILENT WALL BYTUM.....	62
SILENT GIPS	65
GIPS BAND	66
CONSTRUCTION SEALING.....	67
TRASPIR METAL.....	70

from page
55

CONTENTS

STRUCTURAL NOISE

Noise that propagates through the structure and carries vibrations even between non-contiguous rooms.

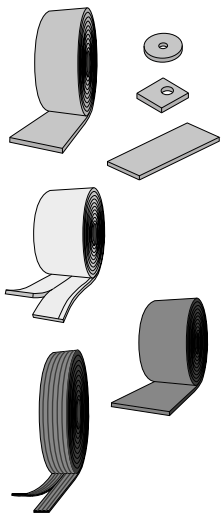

XYLOFON	88
XYLOFON WASHER	102
XYLOFON PLATE	104
PIANO	106
CORK	116
ALADIN	118
TRACK	122
GRANULO STRIPE	124
TIE-BEAM STRIPE	126

from page
83

ACOUSTIC AND SEALING

Air is one of the main medium through which sound waves propagate. Even the smallest gap allows noise to spread and affects the final performance of the building element.

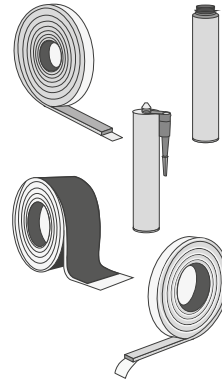

FIRE SEALING SILICONE	140
MS SEAL	143
HERMETIC FOAM	144
EXPAND BAND	146
WINDOW BAND	148
PLASTER BAND IN/OUT	150
SMART BAND	158

from page
135

A SOLUTION FOR EVERY TYPE OF NOISE

? Does the noise of the condominium lift keep you awake at night?

You have a problem with **SYSTEM VIBRATION NOISE**

The noise level produced by the systems is evaluated according to the type of operation.

Lifts, plumbing drains and toilets are discontinuous systems; heating, ventilation and air conditioning are continuous systems.



? Don't the trams passing under your house make you hear the TV?

You have a problem with **AIRBORNE FAÇADE NOISE**

Noise arriving from outside, such as passing vehicles, can cause the façade to vibrate through vertical and horizontal partitions due to the sound waves they emit. Therefore, good design and verification of the components is necessary in order to preserve the well-being within the building.

? Can you hear the noise of the child jumping upstairs?

You have a problem with **IMPACT NOISE**

When a body impacts on the floor structure, the noise quickly spreads throughout the building either by air, affecting the nearest rooms, or by structure, propagating into the most distant rooms.

? Is there an annoying background noise in your room?

You have a problem with **ACOUSTIC REVERBERATION**

Reverberation is the phenomenon that occurs due to the persistence of a sound wave in an enclosed environment, even after the sound source has ceased emitting the wave. This is because the sound wave "bounces" off surfaces and is reflected in the surroundings.

? Can you hear your neighbour having a conversation?

You have a problem with **AIRBORNE NOISE**

Airborne noise is a set of sound waves that originates in the air and is then transmitted into adjacent rooms either by air or by structure.

The acoustic design of a building must go through an analysis of the type of noise. Once the source of the problem has been identified, the most suitable solution can be found to improve the acoustic performance of the building component.

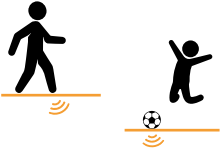

IMPACT NOISE

Walking, moving a chair, moving any object resting on the floor leads to mechanical excitation of the floor and, consequently, to what is known as impact noise.

*Stop the broomstick, go to **Chapter 1.***

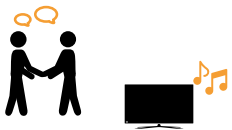

AIRBORNE NOISE

It is transmitted in the air and is part of our everyday life: chatting, listening to music, playing with children.

*You can always turn down the volume but also discover the alternatives in **Chapter 2.***



STRUCTURAL NOISE

It occurs when noise propagation passes through the structure and spreads vibrations not only to adjacent rooms, but also to rooms not necessarily separated by walls or floors.

*Solve the problem at the base, go to **Chapter 3.***

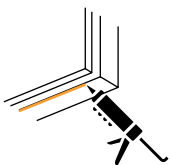

ACOUSTIC AND SEALING

The sound wave propagates in the air, which makes it easy to spread and difficult to control. Precise design helps to avoid overlooking details that could compromise the building's acoustic performance.

*The solution is not in the air, discover **Chapter 4.***



LOGARITHMIC SCALE

Since the decibel is a logarithmic quantity, it can be said that a 3 dB increase is equivalent to a doubling of sound energy (conversely, if we halve the sound energy, there will be a 3 dB reduction).

$$118 \text{ dB} + 3 \text{ dB} = 118 \text{ dB} + 118 \text{ dB}$$

Each 10 dB increase corresponds to an increase in sound energy of 10 times.

$$118 \text{ dB} + 10 \text{ dB} = 118 \text{ dB} + 118 \text{ dB} + 118 \text{ dB} + 118 \text{ dB} + 118 \text{ dB} + 118 \text{ dB} + 118 \text{ dB} + 118 \text{ dB} + 118 \text{ dB} + 118 \text{ dB}$$





REFERENCES

MARIE CURIE SCHULE Frankfurt (DE)

When building a school, creating a healthy climate inside the classroom is a fundamental prerequisite for good learning. The selection of top-quality materials, the use of highly specialised labour and design to high standards allow for excellent results in terms of emissions, thermal and acoustic insulation. Measurements carried out on the finished building showed a performance that far exceeded the high requirements of the German standard: the sound reduction index of the wall recorded $R'_w=67$ dB, while for the floor, an impact sound pressure level $L'_{nT,w}=41$ dB was achieved.

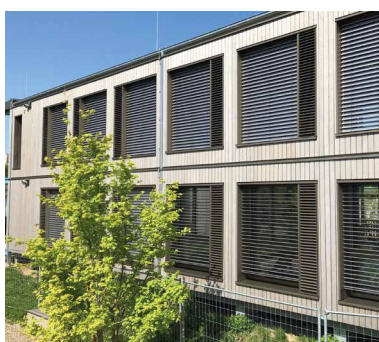

description	building for school use
type of structure	CLT panels
location	Frankfurt (Germany)
products	XYLOFON

STERNAECKERWEG Graz (AT)

The construction of 400 timber housing units presents a challenge for acoustic comfort. Thanks to the use of XYLOFON and a detail-oriented construction, it was possible to achieve $R'_w=66$ dB ($D_{nt,w}=70$ dB) for the partition wall and a high-performance ceiling, both in terms of airborne noise transmission $R'_w=62$ dB ($D_{nt,w}=62$ dB), and the impact sound pressure level $L'_{n,w}=50$ dB ($L'_{nT,w}=47$).



description	400 housing units + childcare facility
type of structure	CLT panels
location	Graz (Austria)
products	XYLOFON

RESIDENTIAL BUILDING Tirol (AT)

The contribution of lateral transmission can be quite significant. For this reason, the acoustic designer planned the use of XYLOFON to structurally interrupt the propagation of vibrations and consequently reduce noise transmission. This design approach resulted in a high-performance floor: $D_{nt,w}=63$ dB and $L'_{nt,w}=45$ dB were measured on completion.



description	multi-storey building (3 floors) for residential use
type of structure	CLT panels
location	Tyrol (Austria)
products	XYLOFON

RESIDENTIAL BUILDING Trentino Alto Adige (IT)

The project consisted in the assembly of a multi-storey prefabricated timber building, using an innovative point-to-point connection system. The correct design of the construction assembly and the use of XYLOFON to minimise lateral transmission allowed us to measure $R'_w=60$ dB for the partition wall and $R'_w= 56$ dB for the floor.



description	multi-storey building (3 floors) for residential use
type of structure	CLT panels
location	Trentino Alto Adige (Italy)
products	XYLOFON

MULTI-STOREY BUILDING Bavaria (DE)

Timber structures must be designed with a different approach than traditional structures: the propagation of vibrations must be interrupted at the structural level in order to have a reduction in noise transmission. XYLOFON significantly reduces it and on this particular building site, the sound reduction index of the wall $R'_w=64$ dB was measured.

description	multi-storey building (3 floors) for residential use
type of structure	CLT panels
location	Bavaria (Germany)
products	XYLOFON



MOHOLT STUDENT Trondheim (NO)

Moholt is the largest student village in Trondheim, whose university is renowned for its international environment, with students from all over the world.

The project aims to provide not only accommodation, but also to facilitate students' lives through support services and facilities.

At Moholt, special attention was paid to environment and comfort: the structures were made of CLT and XYLOFON was used to create an elastic separation layer between rigid structural elements. This construction technique avoids the transmission of vibrations between components and solves the acoustic problem at its root.

description	university campus consisting of living spaces and services
type of structure	CLT panels
location	Trondheim (Norway)
products	XYLOFON

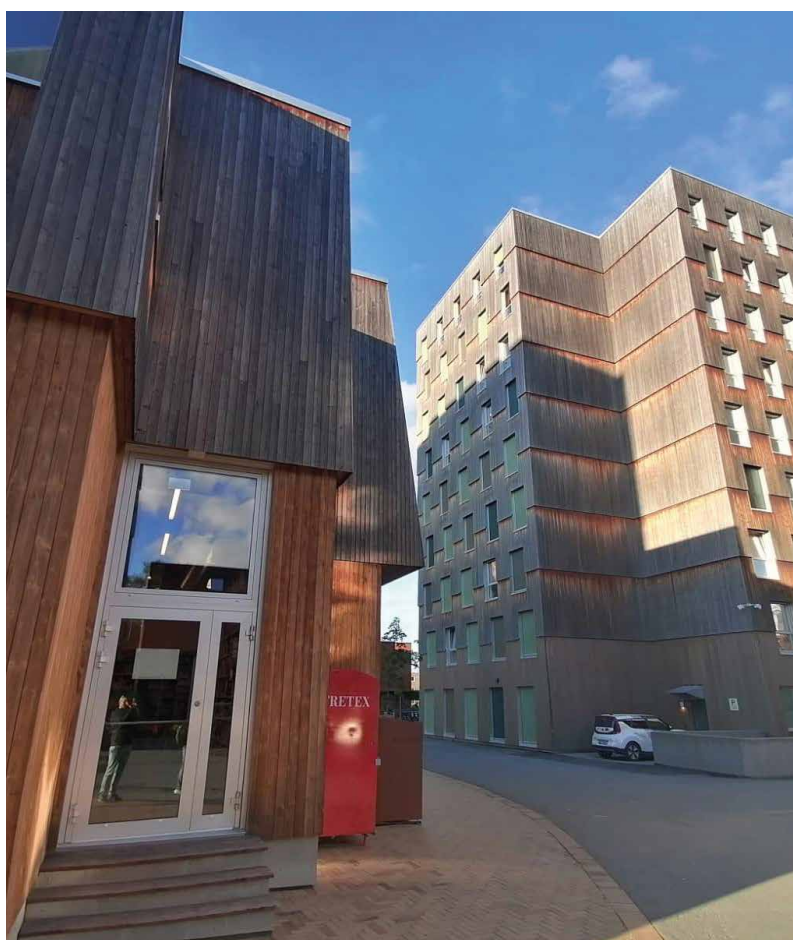

SOLHØY Østlandet (NO)

The 11500 m² timber building, intended for care and nursing, being a health centre, also presents a challenge in terms of acoustic comfort. In the design, particular attention was paid to the choice of materials and construction details, to create cosy spaces that can promote the recovery of in-patients. XYLOFON was chosen because it significantly reduces the transmission of vibrations, while at the same time ensuring stability and no failure over time.



description	health centre consisting of 67 health-care flats with attached user services
type of structure	CLT panels
location	Østlandet (Norway)
products	XYLOFON

LA BRIOSA HOTEL Trentino Alto Adige (IT)

The project stems from the renovation of a historic masonry building, with the integration of a new timber structure, and skilfully combines respect for tradition with innovative design. A totally sustainable project, in which no glues, nails or paints are used, requires materials that are stable, will not fail over time and are waterproof, which is why XYLOFON proved to be the best choice for the project.



description	7-storey building for accommodation use
type of structure	CLT panels
location	Trentino Alto Adige (Italy)
products	XYLOFON, ALADIN, TITAN SILENT

RESIDENTIAL COMPLEX Île-de-France (FR)

The project is located within an eco-neighbourhood full of new generation living spaces, shops and services, school environments, cycle paths and green spaces. Keeping an eye on acoustic comfort design, it was necessary to keep the structural elements separate with XYLOFON to prevent the propagation of vibrations, and thus noise, through the structure.



description	multi-storey residential building complex consisting of 78 residential units
type of structure	mixed concrete and CLT panel elevation
location	Île-de-France (France)
products	XYLOFON

KIHLSTRÖMSKAJ Götaland (SE)

The project highlights the full potential of timber as a building material, also for the construction of apartment blocks and multi-storey buildings. In addition to the environmental benefits of renewable building materials, timber also offers a pleasant and cosy atmosphere. The complex has been divided into three buildings grouped around a common courtyard that opens onto the archipelago. The proximity to the sea requires the use of extremely chemically stable and impermeable materials. XYLOFON, with its monolithic structure, meets these requirements perfectly.



description	residential complex consisting of approximately 40 residential units
type of structure	CLT panels
location	Götaland (Sweden)
products	XYLOFON, ALADIN

UNIVERSITY CAMPUS Victoria [AU]

In addition to being a modern student hall, this project had the ambitious goal of becoming the new benchmark for sustainable building design and construction in Australia. It is a timber student house that is completely powered by renewable energy sources that produce many environmental benefits. XYLOFON and many other Rothoblaas solutions have been used to ensure user comfort.



description	university student residence with 150 beds
type of structure	CLT panels
location	Victoria (Australia)
products	XYLOFON, ALADIN

MULTI-STOREY BUILDING Toronto [CA]

The project was born out of the desire to optimise the construction process through the use of prefabricated CLT panels, maximise natural light and meet passive requirements. The high degree of airtightness of the envelope has made it possible to minimise heat loss in winter and increase indoor air quality, reducing operating costs and the building's ecological footprint. The challenge, from an acoustic point of view, was to create floors with an exposed timber structure that would guarantee high levels of comfort. Rothoblaas products were chosen for their ability to reduce the lateral transmission of noise propagation through the structure.



description	6-storey building for residential use
type of structure	CLT panels
location	Toronto (Canada)
products	XYLOFON, ALADIN

SMALL RESIDENTIAL BUILDING

Walberswick (GB)

What could be more magical than imagining the silence of a small CLT residential building set in the peace and quiet of a small village on the Suffolk coast of England? Thanks to our connectors, our resilient XYLOFON profile and the SILENT FLOOR BYTUM underscreed foil. This is a dream come true.

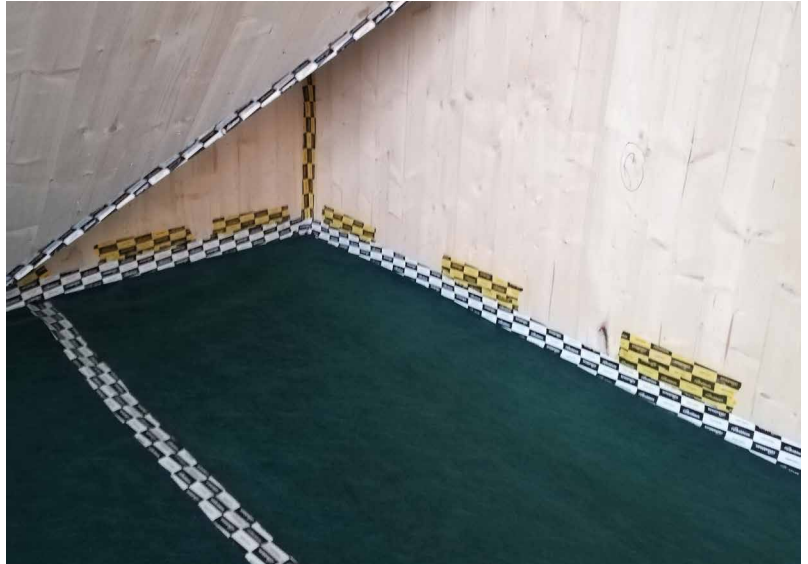

description	small residential building
type of structure	CLT
location	Walberswick (England)
products	XYLOFON, SILENT FLOOR BYTUM

STRUCTURAL RESTORATION

El Pont de Suert (ES)

In this project of structural rehabilitation of an old rural building, the product SILENT FLOOR PE was used to improve the acoustic performance of the floors against impact noise and as a waterproofing layer in order to realise the collaborating concrete layer.

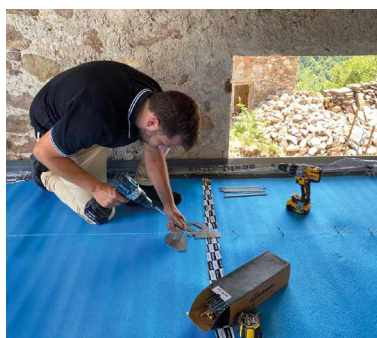

description	rehabilitation of a farmhouse
type of structure	masonry structure with floor reconstruction with beams and boards
location	El Pont de Suert (Spain)
products	SILENT FLOOR PE, SILENT EDGE

COMMERCIAL BUILDING Atlanta (USA)

The newly constructed building boasts office space, restaurants, shops, a hotel and art studios. It is a very innovative project that also uses TIMBER as a structural material. To improve the acoustic performance of the floors, SILENT FLOOR PUR was used and ALADIN was used to reduce lateral transmission.



description	commercial building covering more than 300000 sq ft
type of structure	mixed
location	Atlanta (Georgia, USA)
products	SILENT FLOOR PUR, ALADIN

COMMERCIAL BUILDING Toronto (CA)

In the construction of this new commercial building, SILENT FLOOR BYTUM was used to create a floating screed system to ensure the best acoustic performance of the interior spaces.

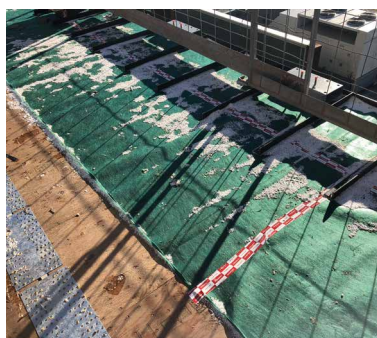
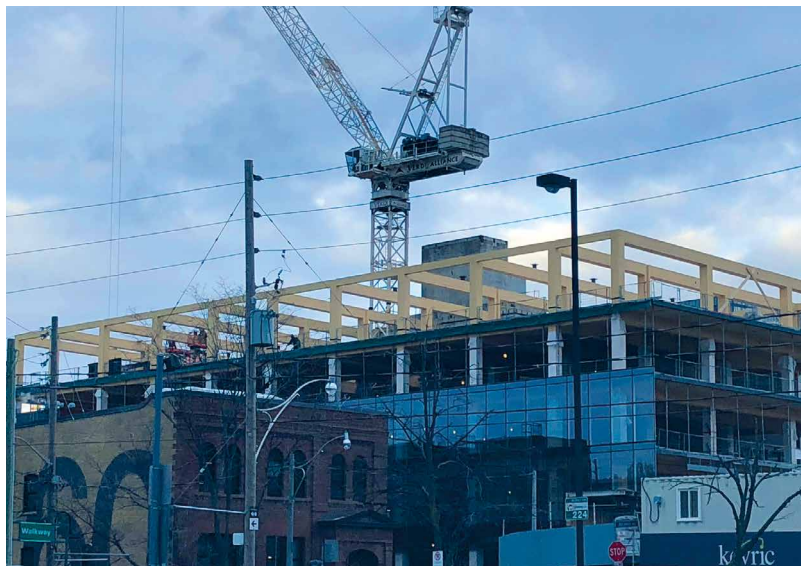

description	commercial building
type of structure	mixed
location	Toronto (Ontario, Canada)
products	SILENT FLOOR BYTUM

IMPACT NOISE

IMPACT NOISE

IMPACT NOISE

SILENT FLOOR PUR <i>RESILIENT HIGH PERFORMANCE UNDERSCREED MEMBRANE MADE OF RECYCLED POLYMERS</i>	28
SILENT FLOOR TEX <i>UNDERSCREED MEMBRANE MADE OF RECYCLED TEXTILE FIBRE AND RECYCLED</i>	32
SILENT FLOOR BYTUM <i>RESILIENT UNDERSCREED MEMBRANE MADE OF BITUMEN AND POLYESTER FELT</i>	34
SILENT FLOOR PE <i>RESILIENT UNDERSCREED MEMBRANE MADE OF CLOSED CELL PE</i>	36
SILENT FLOOR NET 3D <i>BREATHABLE MEMBRANE WITH THREE-DIMENSIONAL RESILIENT MAT</i>	38
SILENT EDGE <i>SELF-ADHESIVE STRIP FOR PERIMETER SEPARATION</i>	40
SILENT STEP <i>HIGH DENSITY POLYETHYLENE SUBSTRATE WITH VAPOUR BARRIER FILM</i>	45
SILENT STEP ALU <i>HIGH DENSITY POLYMER SUBSTRATE COVERED IN ALUMINIUM WITH AS A VAPOUR BARRIER FILM</i>	46
PIANO A <i>RESILIENT SOUNDPROOFING PROFILE</i>	47
SILENT UNDERFLOOR <i>RESILIENT STRIP FOR FLOOR UNDERBATTENS AND SUPPORTING WALLS</i>	48
GRANULO <i>RESILIENT GRANULAR RUBBER SOUNDPROOFING PRODUCT</i>	49

ACOUSTIC PROBLEMS OF FLOORS

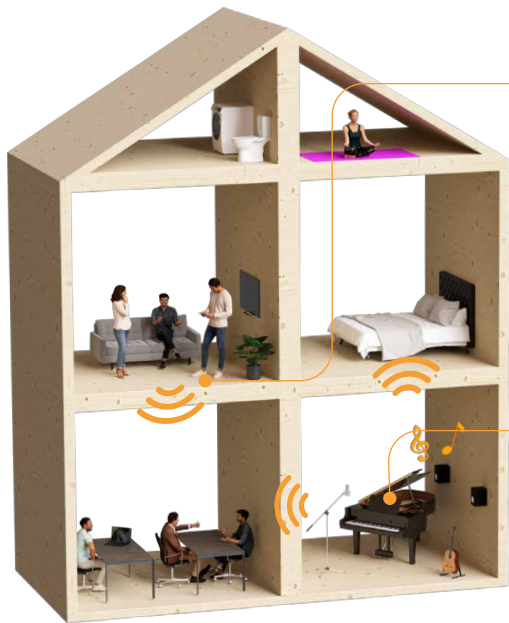

WHAT IS IMPACT NOISE?

When it comes to floors, impact noise is the main acoustic problem because it constantly affects them. When a body impacts on the floor structure, the noise quickly spreads throughout the building either by air, affecting the nearest rooms, or by structure, propagating into the most distant rooms.

WHAT IS AIRBORNE NOISE?

Airborne noise is generated in the air and, after an initial airborne phase, is transported both by air and by structure. This is a problem that affects both walls and floors, but if we are talking about floors, the most important problem is certainly impact noise.

HERE IS THE SOLUTION

In order to be able to minimise the discomfort caused by impact noise, a stratigraphic package should be designed consisting of layers of different materials that are disconnected from each other and are able to dissipate the energy transmitted by the impact.



MASS-SPRING-MASS SYSTEM

A floating screed system such as the one shown in the images below can be schematised with a mass-spring-mass system, in which the structural floor represents the mass, the impact-absorbing product is equivalent to the spring, and the upper screed with the floor constitutes the second mass of the system. In this context, "resilient layer" is defined as the element with the spring function characterised by its own *dynamic stiffness s'*.

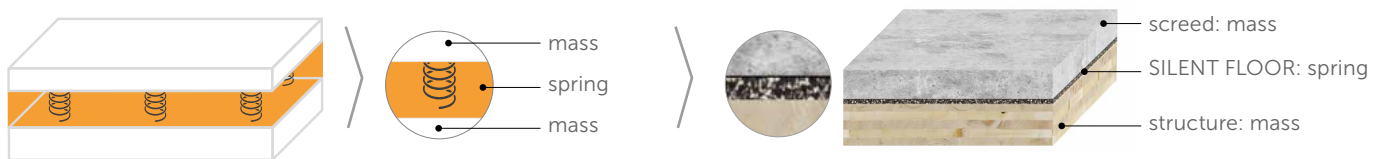

HOW IS THE IMPACT NOISE LEVEL MEASURED?

The impact noise level is a measure of the disturbance perceived in a room when an impact noise source is activated in the upper room. It can be measured both on site and in the laboratory. Clearly, ideal conditions exist in the laboratory for the effects of lateral transmission to be neglected, as the laboratory itself is constructed so that the walls are decoupled from the ceiling.

TAPPING MACHINE method

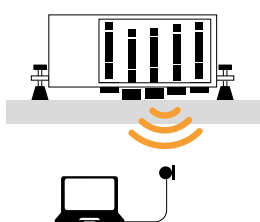

The TAPPING MACHINE is used to simulate "light" and "hard" impacts, such as walking with heeled shoes or the impact caused by falling objects.

RUBBER BALL method

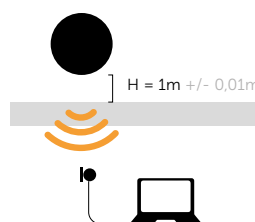

The RUBBER BALL is used to simulate "soft" and "heavy" impacts, such as a barefoot walk or a child jumping.

HOW TO CHOOSE THE BEST PRODUCT

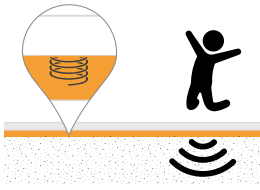

DYNAMIC STIFFNESS – s'

Expressed in MN/m^3 , it is measured according to EN 29052-1 and expresses the deformation capacity of a material that is subjected to a dynamic stress. Consequently, it indicates the ability to dampen the vibrations generated by an impact noise.

The measurement method involves, first, measuring the *apparent dynamic stiffness* s'_t of the material and then correcting it, if necessary, to obtain the *real dynamic stiffness* s' . Dynamic stiffness depends in fact on the *flow resistivity* r , which is measured in the lateral direction of the sample. If the material has specific flow resistivity values, the apparent dynamic stiffness must be corrected by adding the contribution of the gas contained within the material: air.

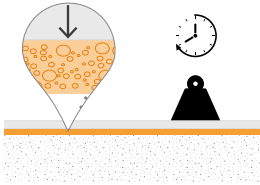

VISCOUS SLIDING UNDER COMPRESSION – CREEP

Expressed as a percentage, it is measured according to EN 1606 and represents the long-term deformation of a material under constant load to be simulated. The measurement in the laboratory must be carried out over a period of at least 90 days.

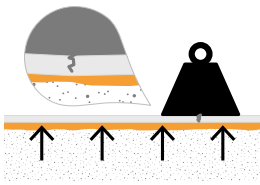

COMPRESSIBILITY - c

The compressibility class expresses the behaviour of a material while subjected to screed loading. During measurement, the product is subjected to different loads and its thickness is measured. The compressibility measurement is carried out to understand what loads the underscreed product can withstand, in order to avoid cracking and splitting of screeds.

CORRECT INSTALLATION

The technological solution of the floating screed is one of the most widely used and one of the most effective, but in order to achieve satisfactory results it is important that the system is designed and implemented correctly.

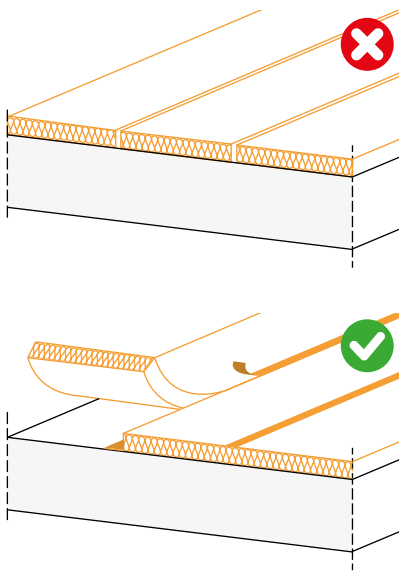

The resilient layer must be continuous because any gap would represent an acoustic bridge. When installing underscreed mats, care must be taken not to create discontinuities.

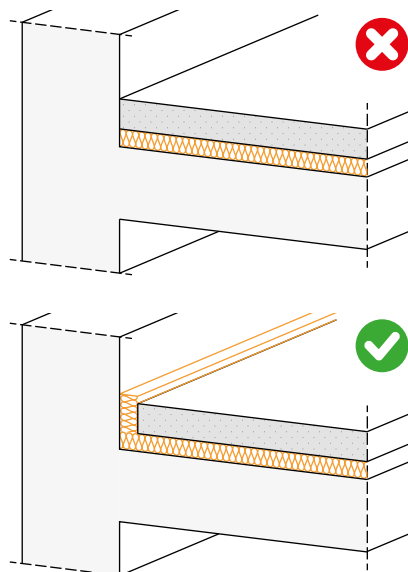

It is important to use the SILENT EDGE perimeter strip to ensure that the resilient layer is continuous around the entire perimeter of the room. The SILENT EDGE should only be trimmed after the floor has been installed and grouted.

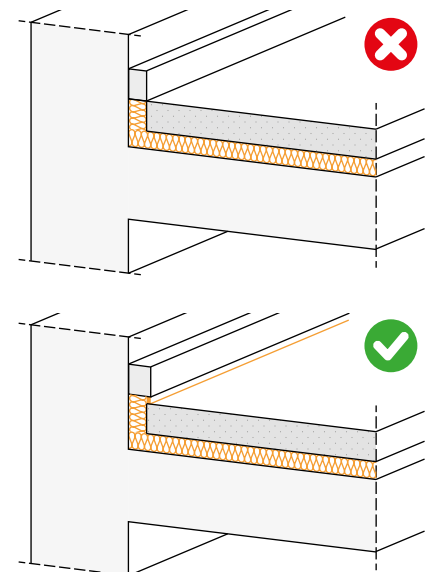

The skirting board must be installed after the SILENT EDGE has been cut, ensuring that it is always suitably raised from the floor.

IIC vs L_w

IIC stands for **Impact Insulation Class** and is the value obtained by subtracting the noise level measured in the receiving room from the noise level measured in the source room. Impact Insulation Class, sometimes referred to as Impact Isolation Class, measures the resistance of the floor construction assembly against the propagation of impact-generated noise.

SILENT FLOOR

SOLUTIONS AGAINST IMPACT NOISE

TESTED, EFFECTIVE, VERSATILE

With regard to the flooring, there is a need for underfloor insulation solutions. These are elements with the task of absorbing vibrations and this is made possible by their ability to absorb the energy released during impact on the floor. If this energy is left without barriers, it would otherwise be converted into sound waves, disturbing adjacent rooms.

Our range of underscreeds offers different solutions depending on the weight of the top layers installed on the resilient products (screed thickness). Test results of all products in this family are also available in real applications with effectiveness between 30 and 40 dB. The range consists of different solutions in made of different materials depending on the intended use.



EFFECTIVE

The products in the range, installed with SILENT EDGE, provide a perfect, acoustically effective and watertight floating screed system.

DURABLE

The materials used in the production of this product range, although so different from each other, ensure stability and durability and guarantee high resilience.

SIMPLE

Thanks to the integrated adhesive strip, when present, or Rothoblaas adhesive tapes, the seamless installation of underscreed products is easy and straightforward.



SILENT FLOOR PUR

CODES AND DIMENSIONS

SILENT FLOOR PUR

CODE	H ⁽¹⁾	L	s	A _f ⁽²⁾	H ⁽¹⁾	L	s	A _f ⁽²⁾	
	[m]	[m]	[mm]	[m ²]	[ft]	[ft]	[in]	[ft ²]	
SILFLOORPUR10	1,6	10	10	15	5' 3"	32' 9 3/4"	0.39	161	6
SILFLOORPUR15	1,6	8	15	12	5' 3"	26' 3"	0.59	129	6
SILFLOORPUR20	1,6	6	20	9	5' 3"	19' 8 1/4"	0.79	97	6

⁽¹⁾1.5 m of agglomerate and vapour barrier + 0.1 m of vapour barrier for overlap with integrated adhesive strip (4' 11" + 3 7/8").

⁽²⁾Without considering the overlap area.

SILENT FLOOR TEX

CODE	H ⁽¹⁾	L	s	A _f ⁽²⁾	H ⁽¹⁾	L	s	A _f ⁽²⁾	
	[m]	[m]	[mm]	[m ²]	[ft]	[ft]	[in]	[ft ²]	
SILFLOORTEX6	1,10	10	6	10	3' 7 1/4"	32' 9 3/4"	0.24	108	12
SILFLOORTEX10	1,10	10	10	10	3' 7 1/4"	32' 9 3/4"	0.39	108	6
SILFLOORTEX15	1,10	5	15	5	3' 7 1/4"	16' 4 7/8"	0.59	54	12

⁽¹⁾1 m of felt and vapour barrier + 0.10 m vapour barrier for overlap with integrated adhesive strip (3' 3 3/8" + 3 7/8").

⁽²⁾Without considering the overlap area.

SILENT FLOOR BYTUM

CODE	H ⁽¹⁾	L	s	A _f ⁽²⁾	H ⁽¹⁾	L	s	A _f ⁽²⁾	
	[m]	[m]	[mm]	[m ²]	[ft]	[ft]	[in]	[ft ²]	
SILFLOORBYT5	1,05	10	5	10	3' 5 3/8"	32' 9 3/4"	0.20	108	20

⁽¹⁾1 m of felt and bituminous membrane + 0.05 m of bituminous membrane for overlap (3' 3 3/8" + 2").

⁽²⁾Without considering the overlap area.

SILENT FLOOR PE

CODE	H	L	s	A	H	L	s	A	
	[m]	[m]	[mm]	[m ²]	[ft]	[ft]	[in]	[ft ²]	
SILFLOORPE6	1,55	50	5	77,5	5' 1"	164' 1/2"	0.20	834	4
SILFLOORPE10	1,30	50	10	65	4' 3 1/8"	164' 1/2"	0.39	700	2

SILENT FLOOR NET 3D

CODE	H	L	s	A	H	L	s	A	
	[m]	[m]	[mm]	[m ²]	[ft]	[ft]	[in]	[ft ²]	
SILTNET20	1,0	16	20	16	3' 3 3/8"	52' 5 7/8"	0.79	172	4

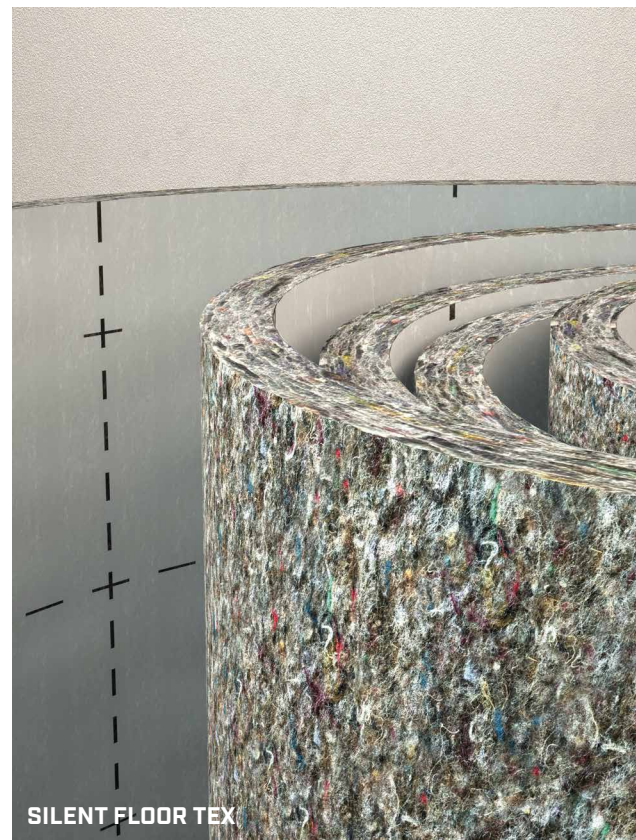



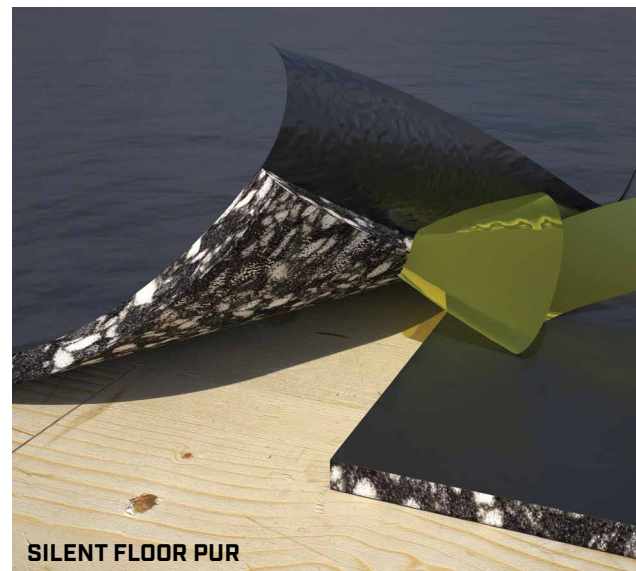



























SILENT FLOOR TEX



SILENT FLOOR PUR

PRODUCT COMPARISON

products	integrated adhesive strip		material
<p>SILENT FLOOR PUR</p> 	<p>✓</p>		<p>polyurethane agglomerate made from pre-consumer industrial waste laminated with polyethylene vapour barrier</p>
<p>SILENT FLOOR BYTUM</p> 	<p>-</p>		<p>polyester fibre felt made from post-consumer waste laminated to an elastoplastic bitumen waterproofing membrane</p>
<p>SILENT FLOOR TEX</p> 	<p>✓</p>		<p>textile fibre felt laminated with a polyethylene vapour barrier, both made from pre-consumer industrial waste</p>
<p>SILENT FLOOR PE</p> 	<p>-</p>		<p>closed cell expanded polyethylene</p>
<p>SILENT FLOOR NET 3D</p> 	<p>-</p>		<p>three-dimensional mat laminated with a non-woven fabric and a three-layer breathable membrane, all made of polypropylene</p>

thickness	dynamic stiffness	load	estimate ΔL_w						
			according to formula C.4 of EN ISO 12354-2						
			10	15	20	25	30	35	40
10 mm <i>0.39 in</i>	12,5 MN/m³	125 kg/m ²							
		200 kg/m ²							
		250 kg/m ²							
15 mm <i>0.59 in</i>	8,8 MN/m³	125 kg/m ²							
		200 kg/m ²							
		250 kg/m ²							
20 mm <i>0.79 in</i>	7,4 MN/m³	125 kg/m ²							
		200 kg/m ²							
		250 kg/m ²							
5 mm <i>0.20 in</i>	27 MN/m³	125 kg/m ²							
		200 kg/m ²							
		250 kg/m ²							
6 mm <i>0.24 in</i>	33 MN/m³	125 kg/m ²							
		200 kg/m ²							
		250 kg/m ²							
10 mm <i>0.39 in</i>	25 MN/m³	125 kg/m ²							
		200 kg/m ²							
		250 kg/m ²							
15 mm <i>0.59 in</i>	22 MN/m³	125 kg/m ²							
		200 kg/m ²							
		250 kg/m ²							
5 mm <i>0.20 in</i>	43 MN/m³	125 kg/m ²							
		200 kg/m ²							
		250 kg/m ²							
10 mm <i>0.39 in</i>	41 MN/m³	125 kg/m ²							
		200 kg/m ²							
		250 kg/m ²							
20 mm <i>0.79 in</i>	21,1 MN/m³	125 kg/m ²							
		200 kg/m ²							
		250 kg/m ²							

SILENT FLOOR PUR

RESILIENT HIGH PERFORMANCE UNDERSCREED MEMBRANE MADE OF RECYCLED POLYMERS

CERTIFIED

The effectiveness of the underscreed membrane has been certified in the labs of the Centre for Industrial Research of the University of Bologna.

SUSTAINABILITY

Recycled and recyclable. The product intelligently reuses polyurethane from production waste that would otherwise have to be disposed of.

HIGH PERFORMANCE

The special composition offers excellent elasticity, reaching attenuation values over 30 dB.

COMPOSITION

polyethylene vapour barrier

polyurethane agglomerate made from pre-consumer industrial waste

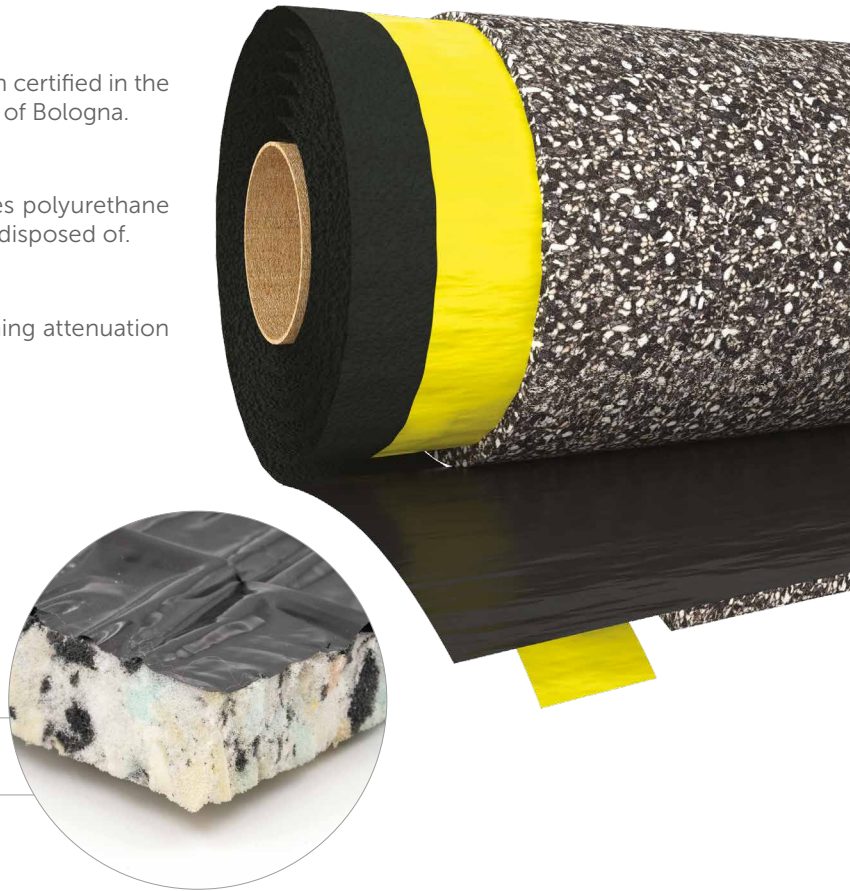

CODES AND DIMENSIONS

CODE	H ⁽¹⁾ [m]	L [m]	thickness [mm]	A _f ⁽²⁾ [m ²]	H ⁽¹⁾ [ft]	L [ft]	thickness [in]	A _f ⁽²⁾ [ft ²]	
SILFLOORPUR10	1,6	10	10	15	5' 3"	32' 9 3/4"	0.39	161	6
SILFLOORPUR15	1,6	8	15	12	5' 3"	26' 3"	0.59	129	6
SILFLOORPUR20	1,6	6	20	9	5' 3"	19' 8 1/4"	0.79	97	6

⁽¹⁾ 1.5 m of polyurethane agglomerate and vapour barrier + 0.1 m of vapour barrier for overlap with integrated adhesive strip (4' 11" + 3 7/8").

⁽²⁾ Without considering the overlap area.

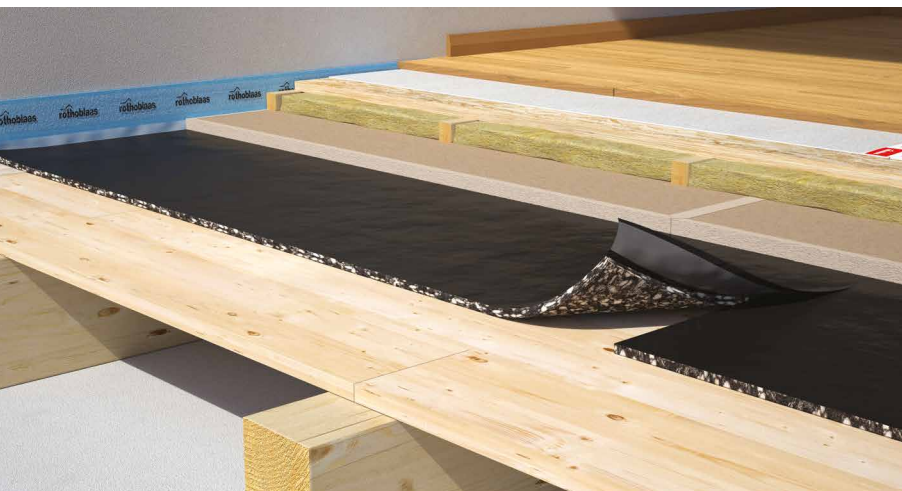

SAFE

Polyurethane is a noble polymer that maintains elasticity over time, without subsidence or changes in performance.

VOC REQUIREMENTS

The membrane composition safeguards health and meets the recommended VOC limits.

TECHNICAL DATA

SILENT FLOOR PUR - 10-15-20 mm thick

Properties	standard	value	USC conversion
Resistance to airflow r	ISO 9053	< 10,0 kPa·s·m ⁻²	-
Compressibility class	EN 12431	CP2	-
CREEP Viscous sliding under compression X_{ct} (1,5 kPa)	EN 1606	7,50 %	-
Compression deformation stress	ISO 3386-1	17 kPa	-
Thermal conductivity λ	-	0,035 W/m·K	0.020 BTU/(h·ft ² ·°F)
Specific heat c	-	1800 J/kg·K	0.43 BTU/(lb·°F)
Water vapour transmission S_d	-	> 100 m	< 0.035 US perm
Reaction to fire	EN 13501-1	class F	-
VOC emission classification	French decree no. 2011-321	A+	-

SILENT FLOOR PUR - 10 mm thick

Properties	standard	value	USC conversion
Surface mass m	-	0,9 kg/m ²	0.18 lb/sft
Density ρ	-	80 kg/m ³	4.9 lb/ft ³
Apparent dynamic stiffness s'_t	EN 29052-1	12,5 MN/m ³	-
Dynamic stiffness s'	EN 29052-1	12,5 MN/m ³	-
Theoretical estimate of impact sound pressure level attenuation ΔL_w ⁽¹⁾	ISO 12354-2	32,5 dB	-
System resonance frequency f_0 ⁽²⁾	ISO 12354-2	50,6 Hz	-
Impact sound pressure level attenuation ΔL_w ⁽³⁾	ISO 10140-3	21 dB	-
Thermal resistance R_t	-	0,46 m ² K/W	-

⁽¹⁾ $\Delta L_w = (13 \lg(m')) - (14,2 \lg(s')) + 20,8$ [dB] con $m' = 125 \text{ kg/m}^2$ (25.60 lb/sft).

⁽²⁾ $f_0 = 160 \sqrt{(s'/m')}$ con $m' = 125 \text{ kg/m}^2$ (25.60 lb/sft).

⁽³⁾Measured in the laboratory on 200 mm (7 7/8") CLT floor. See the manual for more information on configuration.

SILENT FLOOR PUR - 15 mm thick

Properties	standard	value	USC conversion
Surface mass m	-	1,4 kg/m ²	0.29 lb/sft
Density ρ	-	90 kg/m ³	5.6 lb/ft ³
Apparent dynamic stiffness s'_t	EN 29052-1	8,8 MN/m ³	-
Dynamic stiffness s'	EN 29052-1	8,8 MN/m ³	-
Theoretical estimate of impact sound pressure level attenuation ΔL_w ⁽¹⁾	ISO 12354-2	34,6 dB	-
System resonance frequency f_0 ⁽²⁾	ISO 12354-2	42,5 Hz	-
Impact sound pressure level attenuation ΔL_w ⁽³⁾	ISO 10140-3	23 dB	-
Thermal resistance R_t	-	0,52 m ² K/W	-

⁽¹⁾ $\Delta L_w = (13 \lg(m')) - (14,2 \lg(s')) + 20,8$ [dB] con $m' = 125 \text{ kg/m}^2$ (25.60 lb/sft).

⁽²⁾ $f_0 = 160 \sqrt{(s'/m')}$ con $m' = 125 \text{ kg/m}^2$ (25.60 lb/sft).

⁽³⁾Measured in the laboratory on 200 mm (7 7/8") CLT floor. See the manual for more information on configuration.

SILENT FLOOR PUR - 20 mm thick

Properties	standard	value	USC conversion
Surface mass m	-	1,8 kg/m ²	0.37 lb/sft
Density ρ	-	90 kg/m ³	5.6 lb/ft ³
Apparent dynamic stiffness s'_t	EN 29052-1	7,4 MN/m ³	-
Dynamic stiffness s'	EN 29052-1	7,4 MN/m ³	-
Theoretical estimate of impact sound pressure level attenuation ΔL_w ⁽¹⁾	ISO 12354-2	35,7 dB	-
System resonance frequency f_0 ⁽²⁾	ISO 12354-2	38,9 Hz	-
Impact sound pressure level attenuation ΔL_w ⁽³⁾	ISO 10140-3	25 dB	-
Thermal resistance R_t	-	0,92 m ² K/W	-

⁽¹⁾ $\Delta L_w = (13 \lg(m')) - (14,2 \lg(s')) + 20,8$ [dB] con $m' = 125 \text{ kg/m}^2$ (25.60 lb/sft).

⁽²⁾ $f_0 = 160 \sqrt{(s'/m')}$ con $m' = 125 \text{ kg/m}^2$ (25.60 lb/sft).

⁽³⁾Measured in the laboratory on 200 mm (7 7/8") CLT floor. See the manual for more information on configuration



SILENT FLOOR PUR | Tests performed

SOUND REDUCTION INDEX LEVEL MEASUREMENTS

Tests carried out in the **Building Envelope Lab** of the **Free University of Bozen/Bolzano** in accordance with EN ISO 10140-2 have made it possible to measure the impact noise level of the construction assembly described below:

- ① plasterboard panel
- ② timber battens
- ③ strips of **SILENT FLOOR PUR** (s: 10 mm - 0.39 in)
- ④ OSB
- ⑤ insulation material such as rock wool

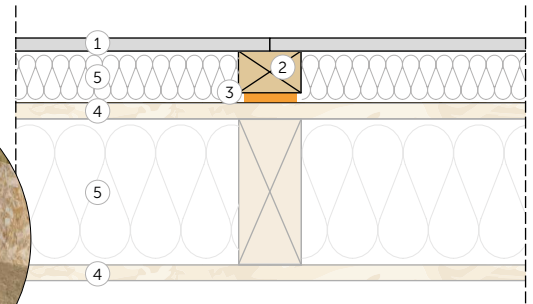

Add the supporting wall to the base frame and decouple it using strips of SILENT FLOOR PUR.

graphs and frequency values available

See the manual for more information on configuration

$$\Delta R_w = + 6 \text{ dB}$$

$$\Delta STC = + 7$$

IMPACT NOISE LEVEL MEASUREMENTS

Tests carried out in the **Building Envelope Lab** of the **Free University of Bozen/Bolzano** in accordance with EN ISO 10140-3 measured the impact noise level of the construction assembly described below:

- ① concrete slab (s: 50 mm - 1.95 in)
- ② **SILENT FLOOR PUR** (s: 20 mm - 0.79 in)
- ③ CLT panel (s: 200 mm - 7.8 in)

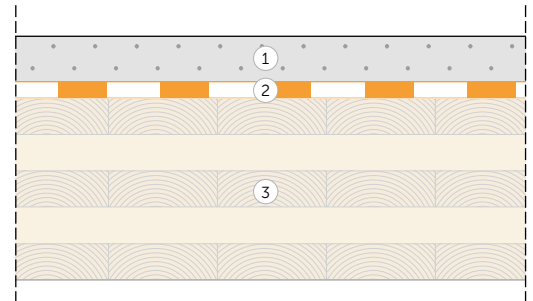

Thanks to the addition of the floating screed system on the raw CLT.

graphs and frequency values available

See the manual for more information on configuration

$$\Delta L_{n,w} = - 25 \text{ dB}$$

$$\Delta IIC = + 25$$

Use the QR-code to download the complete manual!

www.rothoblaas.com



MYPROJECT: FOR AN EASY ACOUSTIC COMFORT



For optimal acoustic comfort design choose MYPROJECT. In the software you will find a module dedicated to acoustic comfort and the automatic calculation of the K_{ij} vibration reduction index. By entering load and design data, you can find the most suitable resilient profile and obtain a complete, customised calculation report. Installation on site will be easier, acoustic comfort will be above expectations.

Scan the QR code and download MYPROJECT



www.rothoblaas.com



rothoblaas

Solutions for Building Technology

SILENT FLOOR TEX

UNDERSCREED MEMBRANE MADE OF RECYCLED TEXTILE FIBRE AND RECYCLED

RECYCLED

The bottom felt is composed of textile fibres derived from production waste, which are then carefully examined and selected.

ACOUSTIC PERFORMANCE

Tested at the University of Bologna according to international standards for acoustic characterisation.

FAST INSTALLATION

Thanks to the integrated adhesive band, installation is simplified by immediately attaching the selvages to the overlaps.

COMPOSITION

polyethylene vapour barrier made from pre-consumer industrial waste

textile fibre felt made from pre-consumer industrial waste



CODES AND DIMENSIONS

CODE	H ⁽¹⁾ [m]	L [m]	thickness [mm]	A _f ⁽²⁾ [m ²]	H ⁽¹⁾ [ft]	L [ft]	thickness [in]	A _f ⁽²⁾ [ft ²]	
SILFLOORTEX6	1,10	10	6	10	3' 7 1/4"	32' 9 3/4"	0.24	108	12
SILFLOORTEX10	1,10	10	10	10	3' 7 1/4"	32' 9 3/4"	0.39	108	6
SILFLOORTEX15	1,10	5	15	5	3' 7 1/4"	16' 4 7/8"	0.59	54	12

⁽¹⁾1 m felt and vapour barrier + 0.10 m vapour barrier for overlap with integrated adhesive strip (3' 3 3/8" + 3 7/8")

⁽²⁾Without considering the overlap area.



WATERPROOF

Thanks to the polyethylene top layer, the product is perfectly impermeable to water and water vapour.

THE RANGE

Different thicknesses and thus technical specifications allow it to be used in different areas and for different screed thickness.

TECHNICAL DATA

SILENT FLOOR TEX - thickness 6 mm

Properties	standard	value	USC conversion
Thickness	-	6 mm	0.24 inch
Density ρ	-	approx. 90 kg/m ³	5.6 lb/ft ³
Resistance to airflow r	ISO 9053	16,4 kPa·s·m ⁻²	-
Apparent dynamic stiffness s'_t	EN 29052-1	18,2 MN/m ³	-
Dynamic stiffness s'	EN 29052-1	33 MN/m ³	-
Compressibility class	EN 12431	CP2	-
Theoretical estimate of impact sound pressure level attenuation ΔL_w ⁽¹⁾	ISO 12354-2	26,5 dB	-
System resonance frequency f_0 ⁽²⁾	ISO 12354-2	82,2 Hz	-
Water vapour transmission Sd	EN ISO 12572	approx. 20 m	approx. 0.17 US perm

⁽¹⁾ $\Delta L_w = (13 \lg(m')) - (14,2 \lg(s')) + 20,8$ [dB] con $m' = 125 \text{ kg/m}^2$ (25.60 lb/sft).

⁽²⁾ $f_0 = 160 \sqrt{(s'/m')}$ con $m' = 125 \text{ kg/m}^2$ (25.60 lb/sft)

SILENT FLOOR TEX - 10 mm thick

Properties	standard	value	USC conversion
Thickness	-	10 mm	0.39 inch
Density ρ	-	approx. 80 kg/m ³	4.9 lb/ft ³
Resistance to airflow r	ISO 9053	31,5 kPa·s·m ⁻²	-
Apparent dynamic stiffness s'_t	EN 29052-1	12,8 MN/m ³	-
Dynamic stiffness s'	EN 29052-1	25 MN/m ³	-
Compressibility class	EN 12431	CP3	-
Theoretical estimate of impact sound pressure level attenuation ΔL_w ⁽¹⁾	ISO 12354-2	28,2 dB	-
System resonance frequency f_0 ⁽²⁾	ISO 12354-2	71,6 Hz	-
Water vapour transmission Sd	EN ISO 12572	approx. 20 m	approx. 0.17 US perm

⁽¹⁾ $\Delta L_w = (13 \lg(m')) - (14,2 \lg(s')) + 20,8$ [dB] con $m' = 125 \text{ kg/m}^2$ (25.60 lb/sft).

⁽²⁾ $f_0 = 160 \sqrt{(s'/m')}$ con $m' = 125 \text{ kg/m}^2$ (25.60 lb/sft)

SILENT FLOOR TEX - 15 mm thick

Properties	standard	value	USC conversion
Thickness	-	15 mm	0.59 inch
Density ρ	-	approx. 100 kg/m ³	6 lb/ft ³
Resistance to airflow r	ISO 9053	24,4 kPa·s·m ⁻²	-
Apparent dynamic stiffness s'_t	EN 29052-1	12,8 MN/m ³	-
Dynamic stiffness s'	EN 29052-1	22 MN/m ³	-
Compressibility class	EN 12431	CP3	-
Theoretical estimate of impact sound pressure level attenuation ΔL_w ⁽¹⁾	ISO 12354-2	29 dB	-
System resonance frequency f_0 ⁽²⁾	ISO 12354-2	67,1 Hz	-
Water vapour transmission Sd	EN ISO 12572	approx. 20 m	approx. 0.17 US perm

⁽¹⁾ $\Delta L_w = (13 \lg(m')) - (14,2 \lg(s')) + 20,8$ [dB] con $m' = 125 \text{ kg/m}^2$ (25.60 lb/sft).

⁽²⁾ $f_0 = 160 \sqrt{(s'/m')}$ con $m' = 125 \text{ kg/m}^2$ (25.60 lb/sft)



PERFORMANCE

Theoretical estimate of impact sound pressure level reduction

ΔL_w : 29 dB

(for 15 mm thickness)



See the manual for more information.

SILENT FLOOR BYTUM

RESILIENT UNDERSCREED MEMBRANE MADE OF BITUMEN AND POLYESTER FELT

TESTED EFFECTIVENESS

The special structure absorbs vibrations from impact noise up to 20 dB.

STRUCTURAL RESTORATION

The material and special structure of the product make it extremely safe even in applications in historic or valuable buildings, as it prevents the screed from percolating in applications with timber and concrete connectors.

HERMETIC

Thanks to the bituminous mixture the membrane tends to close around the fastening system, ensuring watertightness.

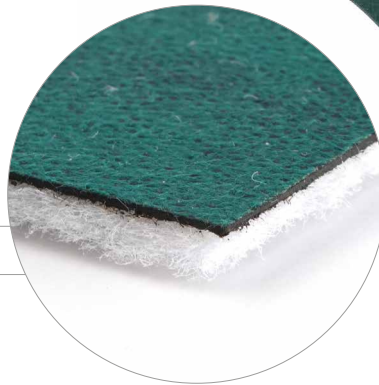
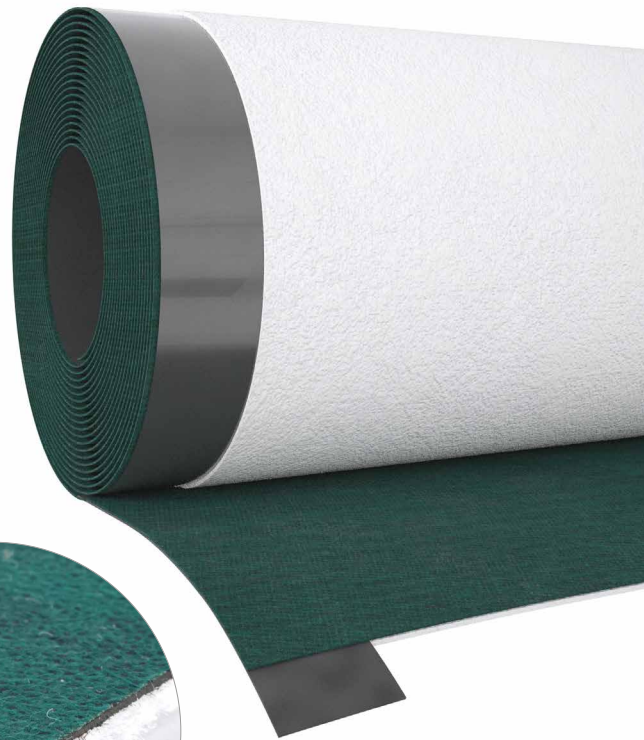

COMPOSITION

elastoplastomeric bitumen waterproofing membrane

polyester fibre felt made from post-consumer waste

CODES AND DIMENSIONS

CODE	H ⁽¹⁾ [m]	L [m]	thickness [mm]	A _f ⁽²⁾ [m ²]	H ⁽¹⁾ [ft]	L [ft]	thickness [in]	A _f ⁽²⁾ [ft ²]	
SILFLOORBYT5	1,05	10	5	10	3' 5 3/8"	32' 9 3/4"	0.20	108	20

⁽¹⁾ 1 m bituminous membrane with felt + 0.05 m bitumen membrane for overlap (3' 3 3/8" + 2").
⁽²⁾ Without considering the overlap area.



DURABLE

Stable over time, thanks to the bituminous mixture. Also highly compatible with fresh concrete.

TIMBER-TO-CONCRETE

Ideal in combination with CTC connectors. Stiffness values also calculated in the presence of vapour barrier sheet or soundproofing layer.

TECHNICAL DATA

Properties	standard	value	USC conversion
Thickness	-	approx. 5 mm ⁽¹⁾	0.20 inch
Surface mass m	-	1,5 kg/m ²	0.30 lb/sft
Density ρ	-	300 kg/m ²	18.7 lb/ft ³
Resistance to airflow r	ISO 9053	> 100,0 kPa·s·m ⁻²	-
Apparent dynamic stiffness s' _t	EN 29052-1	7 MN/m ³	-
Double layer apparent dynamic stiffness ⁽²⁾ s' _t	EN 29052-1	4 MN/m ³	-
Dynamic stiffness s'	EN 29052-1	27 MN/m ³	-
Double layer dynamic stiffness ⁽²⁾ s'	EN 29052-1	14,5 MN/m ³	-
Compressibility class	EN 12431	CP2 (≤ 2 mm)	approx. 0.17 US perm
Double layer compressibility class ⁽²⁾	EN 12431	CP3 (≤ 3 mm)	-
CREEP Viscous sliding under compression X _{ct} (2 kPa)	EN 1606	≤ 1 mm	-
CREEP Viscous sliding under compression double layer ⁽²⁾ X _{ct} (2 kPa)	EN 1606	≤ 1 mm	-
Theoretical estimate of the impact sound pressure level attenuation ΔL _w ⁽³⁾	ISO 12354-2	27,7 dB	-
System resonance frequency f ₀ ⁽⁴⁾	ISO 12354-2	74,4 Hz	-
Impact sound pressure level attenuation ΔL _w ⁽⁵⁾	ISO 10140-3	20 dB	-
Impact sound pressure level attenuation ΔL _w ⁽⁵⁾ double layer ⁽²⁾	ISO 10140-3	21 dB	-
Thermal resistance R _t	ISO 6946	0,13 m ² K/W	-
Thermal conductivity λ	-	0,045 W/m·K 0,17 W/m·K	0.026 BTU/(h·ft ² ·°F) 0.098 BTU/(h·ft ² ·°F)
Specific heat c	-	1,3 kJ/kg·K	0.31 BTU/(lb·°F)
Water vapour resistance factor μ	EN 12086	100000	2500 MN·s/g
Water vapour transmission Sd	-	> 100 m	< 0.035 US perm

⁽¹⁾2 mm bituminous membrane + 3 mm felt (0.08 in + 0.12 in). | ⁽²⁾With opposing white felts. | ⁽³⁾ΔL_w = (13 lg(m')) - (14,2 lg(s')) + 20,8 [dB] with m' = 125 kg/m² (25.60 lb/sft). | ⁽⁴⁾f₀ = 160 √(s'/m') with m' = 125 kg/m² (25.60 lb/sft). | ⁽⁵⁾Measured in the laboratory on 200 mm (7 7/8") CLT floor. See the manual for more information on configuration.

✓ SOUND REDUCTION INDEX LEVEL AND IMPACT NOISE LEVEL MEASUREMENTS

Tests carried out in the **Akustik Center Austria** laboratories of the **Holzforschung Austria** association in accordance with EN ISO 10140-2 and EN ISO 10140-3 made it possible to measure the soundproofing and impact noise level of the construction assembly described below:

- ① concrete screed (s: 60 mm - 2.4 in)
- ② BARRIER 100
- ③ mineral wool insulation (s: 30 mm - 1.2 in)
- ④ compacted gravel fill with cement (s: 80 mm - 3.2 in)
- ⑤ **SILENT FLOOR BYTUM** (s: 5 mm - 0.2 in)
- ⑥ CLT (s: 160 mm - 6.4 in)
- ⑦ metal structure for plasterboard
- ⑧ air chamber (s: 10 mm - 0.39 in)
- ⑨ low density mineral wool insulation (s: 50 mm - 2.0 in)
- ⑩ 2 plasterboard panels (s: 25 mm - 1.0 in)

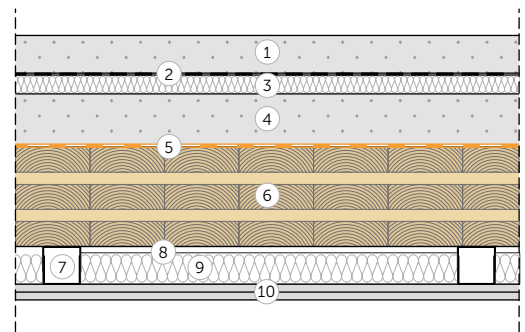

graphs and frequency values available

$$L_{n,w}(Cl) = 42 (0) \text{ dB}$$

$$IIC_{ASTM} = 42$$

$$R_w(C;C_{tr}) = 60 (-1;-4) \text{ dB}$$

$$STC_{ASTM} = 59$$

See the manual for more information on configuration.

Use the QR-code to download the complete manual!
www.rothoblaas.com



SILENT FLOOR PE

RESILIENT UNDERSCREED MEMBRANE MADE OF CLOSED CELL PE

CLOSED CELL

Thanks to the grid of closed cell polyethylene, the foil will not permanently deform and remains effective over time.

COST-PERFORMANCE

Composition of the mixture optimised to provide both good performance and low cost.

VERSATILE

This product is a versatile solution in any application where a light and flexible resilient product is required.

COMPOSITION

closed cell expanded polyethylene

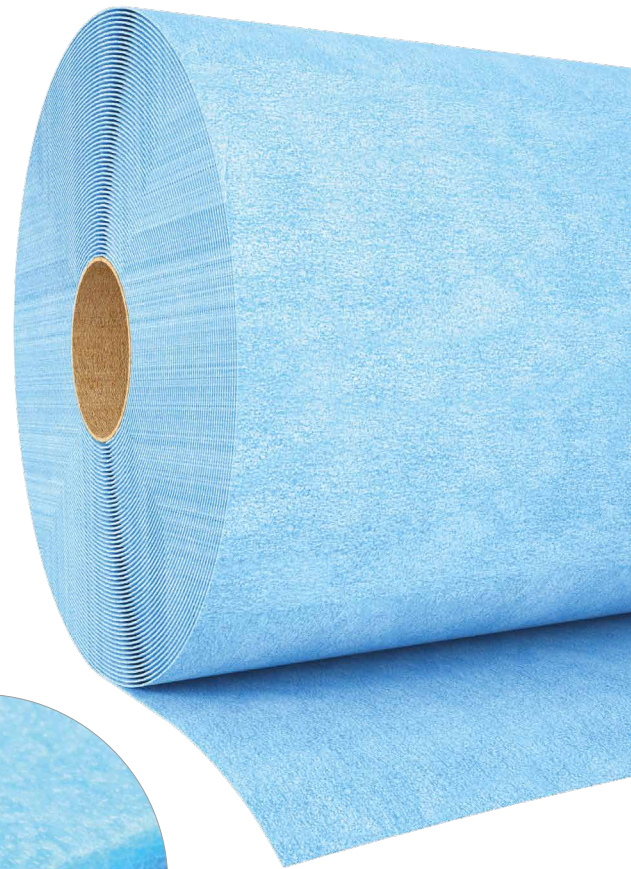

CODES AND DIMENSIONS

CODE	H	L	thickness	A	H	L	thickness	A	
	[m]	[m]	[mm]	[m ²]	[ft]	[ft]	[in]	[ft ²]	
SILFLOORPE6	1,55	50	5	77,5	5' 1"	164' 1/2"	0.20	834	4
SILFLOORPE10	1,30	50	10	65	4' 3 1/8"	164' 1/2"	0.39	700	2

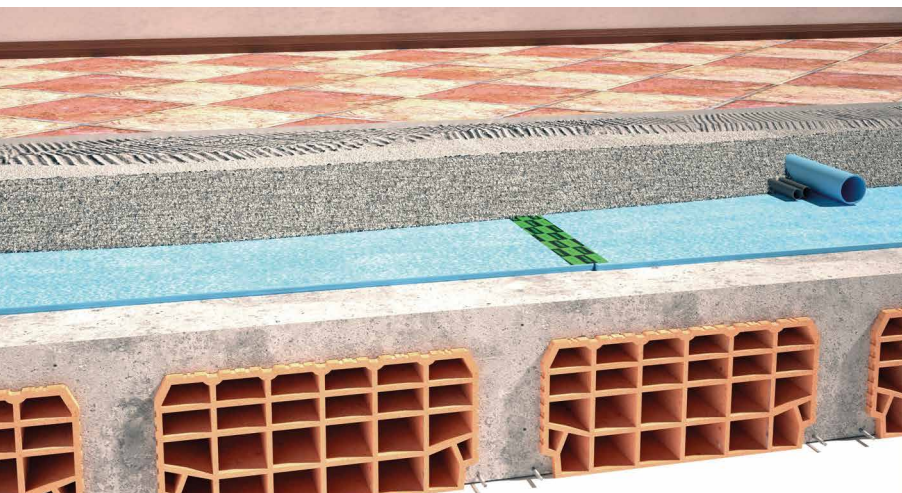

SEVERAL USES

The format and composition offer various uses in the construction field, also as under floor.

STABLE

The grid of polyethylene foam is durable and does not suffer from issues associated with chemical actions or incompatibility of materials.

TECHNICAL DATA

SILENT FLOOR PE - 5-10 mm thick

Properties	standard	value	USC conversion
Density ρ	-	30 kg/m ³	1.9 lb/ft ³
Resistance to airflow r	ISO 9053	> 100.0 kPa·s·m ⁻²	-
Thermal conductivity λ	-	0,038 W/m·K	0.022 BTU/(h·ft ² ·°F)
VOC emission classification	French decree no. 2011-321	A+	-

SILENT FLOOR PE - 5 mm thick

Properties	standard	value	USC conversion
Thickness	-	5 mm	ca. 0.20 in
Surface mass m	-	0,15 kg/m ²	0.03 lb/sft
Apparent dynamic stiffness s'_t	EN 29052-1	43 MN/m ³	-
Dynamic stiffness s'	EN 29052-1	43 MN/m ³	-
Theoretical estimate of impact sound pressure level attenuation $\Delta L_w^{(1)}$	ISO 12354-2	24,9 dB	-
System resonance frequency $f_0^{(2)}$	ISO 12354-2	93,8 Hz	-
Impact sound pressure level attenuation $\Delta L_w^{(3)}$	ISO 10140-3	19 dB	-
Thermal resistance R_t	-	0,13 m ² K/W	-
Water vapour transmission S_d	-	24,1 m	-
Water vapour resistance factor μ	EN 12086	5000	125 MN·s/g

SILENT FLOOR PE - 10 mm thick

Properties	standard	value	USC conversion
Thickness	-	10 mm	ca. 0.39 in
Surface mass m	-	0,30 kg/m ²	0.06 lb/sft
Apparent dynamic stiffness s'_t	EN 29052-1	41 MN/m ³	-
Dynamic stiffness s'	EN 29052-1	41 MN/m ³	-
Theoretical estimate of impact sound pressure level attenuation $\Delta L_w^{(1)}$	ISO 12354-2	25,2 dB	-
System resonance frequency $f_0^{(2)}$	ISO 12354-2	91,6 Hz	-
Impact sound pressure level attenuation $\Delta L_w^{(3)}$	ISO 10140-3	-	-
Thermal resistance R_t	-	0,26 m ² K/W	-
Water vapour transmission S_d	-	48,2 m	-
Water vapour resistance factor μ	EN 12086	5000	250 MN·s/g

(1) $\Delta L_w = (13 \lg(m')) - (14,2 \lg(s')) + 20,8$ [dB] with $m' = 125 \text{ kg/m}^2$ (25.60 lb/sft).

(2) $f_0 = 160 \sqrt{(s'/m')}$ with $m' = 125 \text{ kg/m}^2$ (25.60 lb/sft).

(3) Measured in the laboratory on 200 mm (7 7/8") CLT floor. See the manual for more information on configuration.

IMPACT NOISE LEVEL MEASUREMENTS

Tests carried out in the **Building Envelope Lab** of the **Free University of Bozen/Bolzano** in accordance with EN ISO 10140-3 measured the impact noise level of the construction assembly described below:

- ① concrete slab (s: 50 mm - 2.0 in)
- ② **SILENT FLOOR PE** (s: 5 mm - 0.2 in)
- ③ CLT panel (s: 200 mm - 8.0 in)

- 19 dB

compared to the basic configuration

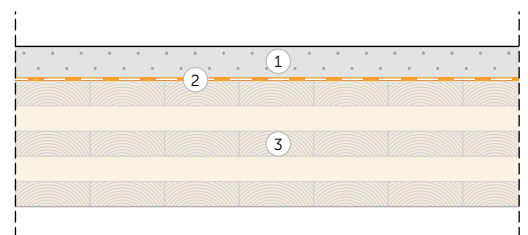

Thanks to the addition of the floating screed system on the raw CLT.

graphs and frequency values available

See the manual for more information on configuration

$$L_{n,w} = -19 \text{ dB}$$

$$IIC_{ASTM} = +19 \text{ dB}$$

Use the QR-code to download the complete manual!

www.rothoblaas.com



SILENT FLOOR NET 3D

BREATHABLE MEMBRANE WITH THREE-DIMENSIONAL RESILIENT MAT

SOUNDPROOFING

The special structure of the three-dimensional mat ensures a reduction in impact noise by acting as a resilient layer.

PROTECTIVE FELT

The fabric protects the three-dimensional mesh from impurities or processing residues that would compromise its functionality.

HIGH DENSITY 3D GRID

The three-dimensional mat has a high mechanical resistance while maintaining the functionality of the product even after the installation and construction phase.

COMPOSITION

breathable three-layer polypropylene membrane

3-dimensional polypropylene mat

non-woven polypropylene fabric

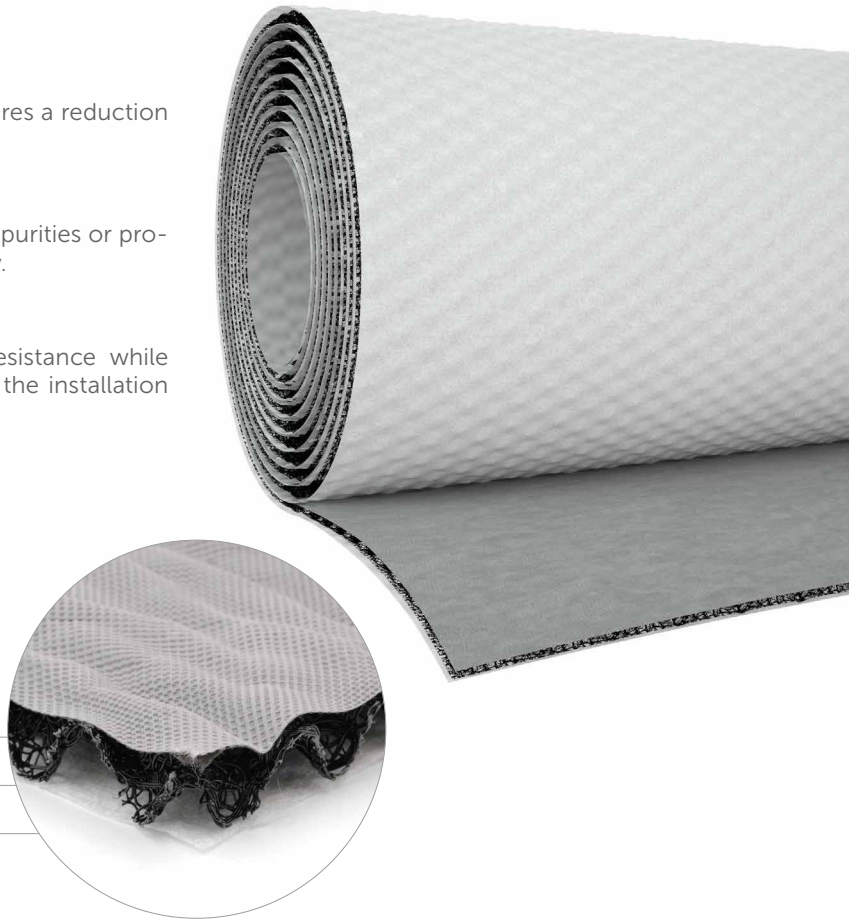

CODES AND DIMENSIONS

CODE	H	L	thickness	A	H	L	thickness	A	
	[m]	[m]	[mm]	[m ²]	[ft]	[ft]	[in]	[ft ²]	
SILTNET20	1,0	16	20	16	3' 3 3/8"	52' 5 7/8"	0.79	172	3



BREATHABLE

The product consists of a three-layer membrane that ensures breathability, air and water impermeability even during installation.

VERSATILE

It can also be used as a micro-ventilation layer in both wall and roof, keeping adjacent layers dry and improving thermo-acoustic performance.

TECHNICAL DATA

Properties	standard	value	USC conversion
Thickness	-	20 mm	0.79 in
Surface mass m	-	1 kg/m ²	0.21 lb/sft
Density ρ	-	50 kg/m ³	30 lb/ft ³
Resistance to airflow r	ISO 9053	< 10,0 kPa s m ⁻²	-
Apparent dynamic stiffness s' _t ⁽³⁾	EN 29052-1	21,1 MN/m ³	-
Dynamic stiffness s' ⁽³⁾	EN 29052-1	21,1 MN/m ³	-
Apparent dynamic stiffness s' _t ⁽⁴⁾	EN 29052-1	29,9 MN/m ³	-
Dynamic stiffness s' ⁽⁴⁾	EN 29052-1	29,9 MN/m ³	-
Compressibility class	EN 12431	CP2	-
Theoretical estimate of impact sound pressure level attenuation ΔL _w ⁽¹⁾	ISO 12354-2	29,3 dB	-
System resonance frequency f ₀ ⁽²⁾	ISO 12354-2	65,6 Hz	-
Thermal conductivity λ	-	0,3 W/(m·K)	0.020 BTU/(h·ft ² ·°F)
Specific heat c	-	1800 J/(kg·K)	0.43 BTU/(lb·°F)
Watertightness	EN 1928	class W1	-
Water vapour transmission Sd	EN ISO 12572	0,03 m	116 US perm
Reaction to fire	EN 13501-1	E	-

⁽¹⁾ΔL_w = (13 lg(m')) - (14,2 lg(s')) + 20,8 [dB] con m' = 125 kg/m² (25.60 lb/sft).

⁽²⁾f₀ = 160 √(s'/m') con m' = 125 kg/m² (25.60 lb/sft).

⁽³⁾Dynamic stiffness value that can be used for creating dry floating screeds (e.g. fiber plaster slabs).

⁽⁴⁾Dynamic stiffness value for creating sand and cement-based floating screeds.

WHAT ABOUT ROOFS? TRASPIR METAL IS FOR THREE

Tested, certified and unique, TRASPIR METAL is the 3D mesh insulation solution for reducing airborne noise and heavy rain.

The product line consists of three-dimensional metal roofing mats with high mechanical strength and excellent protective capacity. TRASPIR 3D COAT TT and 3D NET are composed of materials that promote micro-ventilation and block the entry of impurities into the cover. Both available with a waterproof lower membrane and with draining TNT upper membrane.

Read more on page 70.

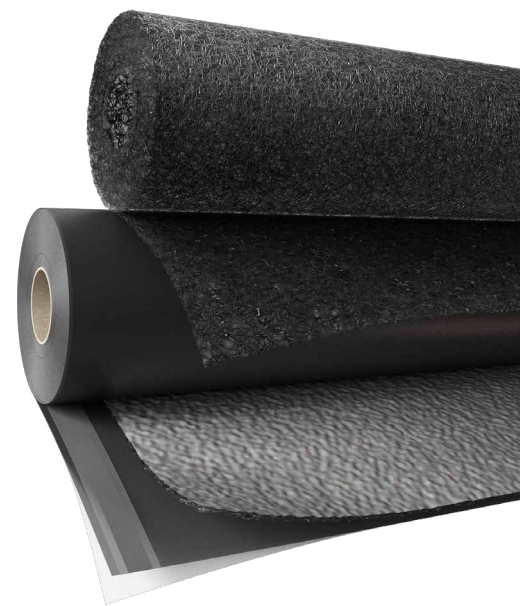

PERFORMANCE

Theoretical estimate of impact sound pressure level reduction

ΔL_w : 29,3 dB

See the manual for more information.



SILENT EDGE

SELF-ADHESIVE STRIP FOR PERIMETER SEPARATION

PRACTICAL

Thanks to the self-adhesive backing, the pre-cut in the liner and the milling, application is fast and precise. Available in different versions.

EXCELLENT PERFORMANCE

Together with SILENT FLOOR range, it creates a highly soundproof floating screed.

SPECIAL ADHESIVE

The special adhesive compound with hotmelt technology is particularly resistant even in high humidity or stagnant water.

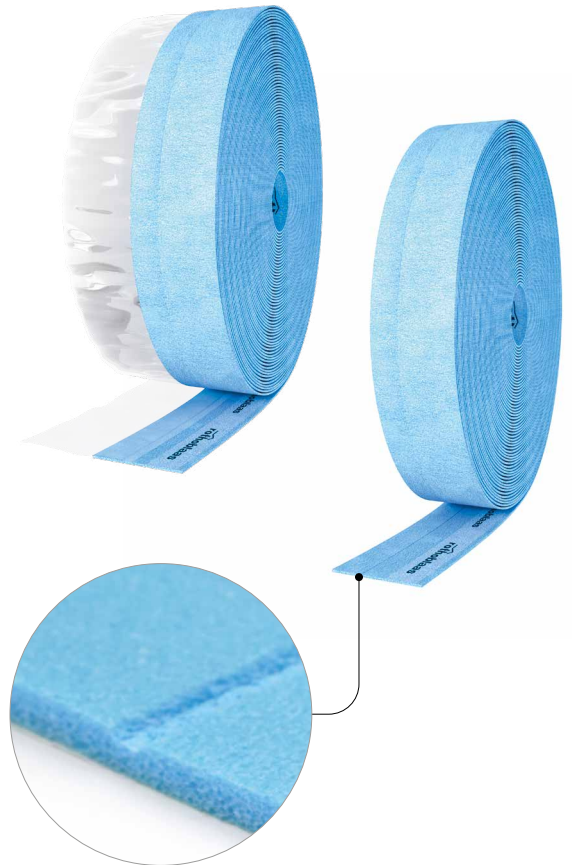

CODES AND DIMENSIONS

VERSION WITH POLYETHYLENE STRAP

CODE	s [mm] [in]	B ₁ [mm] [in]	B ₂ [mm] [in]	H ₁ [mm] [in]	H ₂ [mm] [in]	L [m] [ft]	pcs
SILEDGEH150	6 0.24	50 2"	175 6 7/8"	100 3 7/8"	25 1"	50 164' 1/2"	1

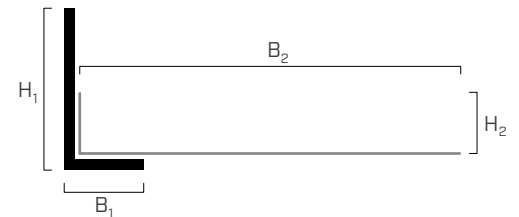

UNIVERSAL VERSION

CODE	s [mm]	B [mm]	H [mm]	L [m]	s [in]	B [in]	H [in]	L [ft]	pcs
SILEDGE150	6	50	100	50	0.24	2"	3 7/8"	164' 1/2"	1
SILEDGE240	6	50	190	50	0.24	2"	7 1/2"	164' 1/2"	1

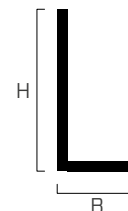

WATERPROOF

Thanks to the closed cell structure, it is airtight and waterproof even if cut or trimmed after application.

VERSATILE

Ideal as a perimeter band in floors undergoing structural renovation and in new buildings.

CERTAIN COLLABORATIONS ARE BORN TO LAST

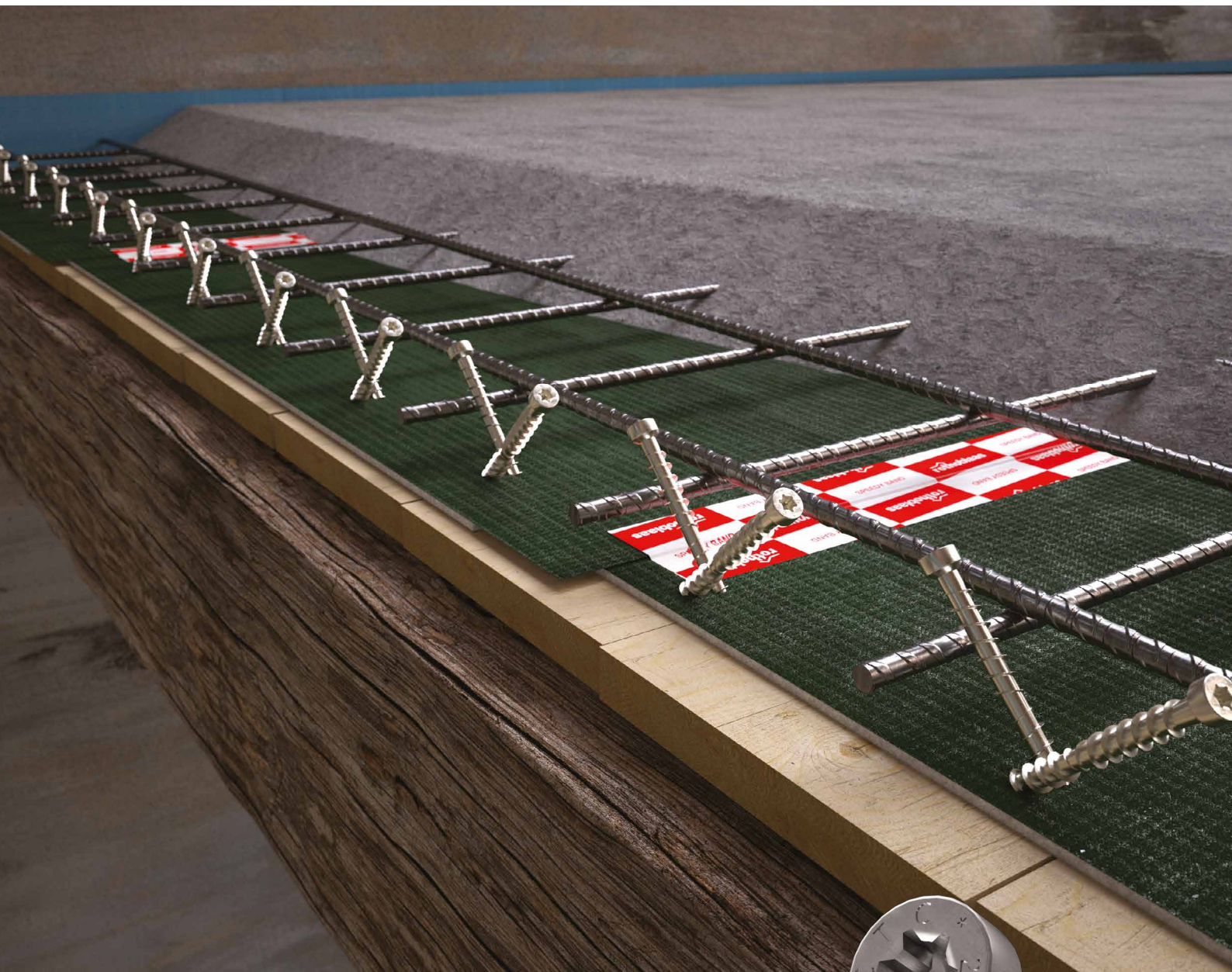

CTC is the connector for timber-to-concrete floors. CE certified, it allows to connect a 5 or 6 cm reinforced concrete slab to the timber beams of the underneath floor, obtaining a new timber-concrete structure with extraordinary strength and excellent static and acoustic performance. It is an approved self-drilling, reversible, fast and minimally invasive system.

Scan the QR code and discover the technical features of CTC connector



www.rothoblaas.com



rothoblaas

Solutions for Building Technology



SILENT FLOOR | Recommendations for installation

PERIMETER STRIP INSTALLATION



SINGLE-LAYER UNDERSCREED MEMBRANE INSTALLATION

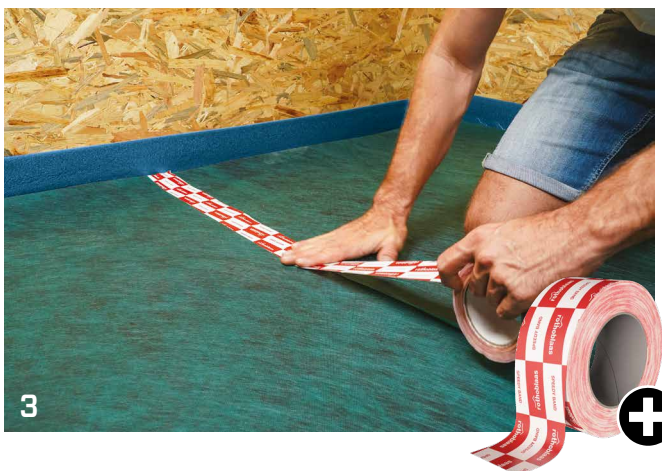

DOUBLE-LAYER UNDERSCREED MEMBRANE INSTALLATION



UNDERFLOOR IMPACT-ABSORBING MATS

WHAT ARE THEY FOR?

Underfloor impact-absorbing mats are the connection between the finish and the respective substrate. In addition to their soundproofing function, they must ensure that the floor can be installed easily and effectively.

EN 16354 specifies test methods to determine the technical properties of the underfloor mat for use under laminate floors and contains minimum performance requirements for the underfloor system to work effectively.

MECHANICAL REQUIREMENTS

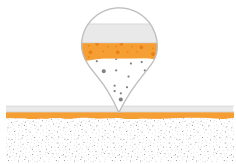

COMPENSATION CAPACITY - **PC**

It is the product's ability to compensate for any unevenness in the substrate on which it is installed and thus eliminate unevenness. In general, the softer the mat, the greater its compensating capacity. This capacity is evaluated by measuring SHORE A according to EN ISO 868 and is expressed in mm. This is a very important property, especially when working on existing sites or working on sites that are not very clean.

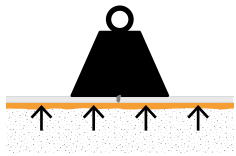

COMPRESSION STRENGTH - **CS**

In order to ensure the integrity of the flooring, the compressive force, expressed in kPa, which causes a deformation of 0,5 mm, according to EN 826, must be determined. The greater the pressure necessary to obtain deformation, the better the product's resistance to compression.



DYNAMIC LOAD RESISTANCE - **DL₂₅**

In order to ensure the integrity of the flooring even under long-term dynamic loads, the Dynamic Load Resistance must be determined according to EN 13793. The DL₂₅ value indicates the number of cycles the material can withstand before reaching a thickness loss ≤ 0.5 mm. Clearly, the higher the number of cycles, the better the strength of the material.

ACOUSTIC REQUIREMENTS



IMPACT SOUND NOISE INSULATION - **IS**

The measurement of the reduction of the impact sound pressure level must be carried out in the laboratory according to EN ISO 10140-3. The index expresses the difference in decibels between the measurement of the impact sound pressure level of the construction assembly with the impact-absorbing mat and the measurement without the insertion of the product.



AIRBORNE NOISE INSULATION - **AS**

The measurement of the apparent soundproofing index R_w must be carried out in the laboratory according to EN ISO 10140-2. It characterises the ability of the partition to limit the passage of airborne noise between two rooms.



INSULATION AGAINST REFLECTED NOISE - **RWS**

The "drum sound" indicates the noise level that is perceived in the room when an impact-type source, such as footsteps, acts on the floor surface of the same room. It is measured in "sone", the higher the RWS value, the less reverberation is perceived within the room.



PROTECTION AGAINST FALLING OBJECTS - **RLB**

The floor has the capacity to absorb high forces of short duration, such as shocks from falling objects. Measured in cm, the higher the RLB value, the higher the level of floor protection.

SILENT STEP

HIGH DENSITY POLYETHYLENE SUBSTRATE WITH VAPOUR BARRIER FILM



PRACTICAL

Thanks to the integrated adhesive tape, sealing is immediate and doesn't require any additional sealing tape.

DAMP BARRIER

The polyethylene film coating prevents the passage of humidity $S_d > 75$ m, protecting the floor.

CODES AND DIMENSIONS

CODE	H ⁽¹⁾ [m]	L [m]	thickness [mm]	A _f ⁽²⁾ [m ²]	H ⁽¹⁾ [ft]	L [ft]	thickness [in]	A _f ⁽²⁾ [ft ²]	
SILENTSTEP	1,10	15	2	15	3' 7 1/4"	49' 2 1/2"	0.08	161	20

⁽¹⁾1 m roll + 0.10 m overlap with integrated adhesive strip (3' 7 1/4" + 3 7/8").

⁽²⁾Without considering the overlap area.

TECHNICAL DATA

Properties	standard	value	USC conversion
Thickness	-	2 mm	0.08 in
Surface mass m	-	0,001 kg/m ²	0.0002 lb/sft
Density ρ	-	0,5 kg/m ³	0.03 lb/ft ³
Water vapour transmission S _d	EN 12086	≥ 75 m	≤ 0.047 US perm
Soundproofing of reflected RWS noise	EN 16205	25 sones	-
Compression strength CS	EN 826	30 kPa	-
CREEP viscous sliding under compression CC (10 kPa)	EN 1606	< 0,5 mm	-
Dynamic load resistance DL ₂₅	EN 13793	10000 cycles	-
Thermal resistance R _t	-	0,06 m ² K/W	-
Impact resistance (Large ball test) RLB ⁽¹⁾	EN 13329	1200 mm	-
Reaction to fire	EN 13501-1	class F	-
VOC emission classification	French decree no. 2011-321	A+	-

⁽¹⁾Under 7 mm (0.28 inch) laminate.



FIELDS OF APPLICATION

FLOOR INSTALLATION

- ✓ floating (not glued)

FLOOR TYPE

- ✓ parquet
- ✓ LVT (medium high quality)
- ✓ laminate

IN-FLOOR HEATING

- ✓ suitable

SILENT STEP ALU



HIGH DENSITY POLYMER SUBSTRATE
COVERED IN ALUMINIUM WITH AS A VAPOUR
BARRIER FILM

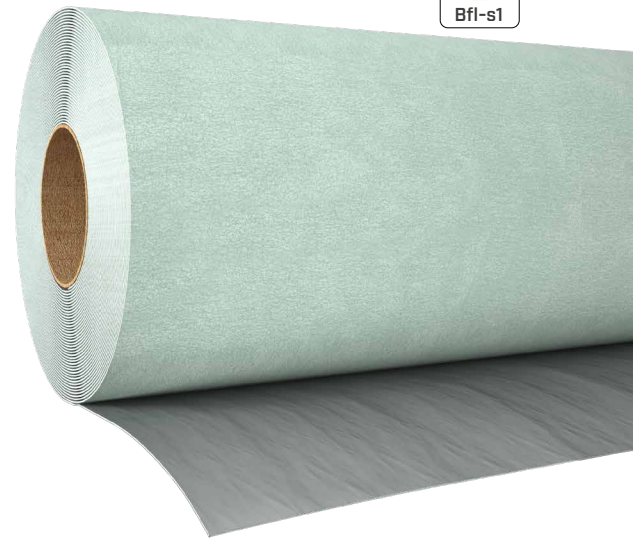

HIGH PERFORMANCE

Coated with an aluminised vapour barrier to protect against rising damp.

REFLECTIVE

Thanks to its extremely heat-conducting material, it is specifically designed for the floating installation of parquet and laminates, even on radiant floors.

CODES AND DIMENSIONS

CODE	H [m]	L [m]	thickness [mm]	A [m ²]	H [ft]	L [ft]	thickness [in]	A [ft ²]	
SILENTSTEPA	1,0	8,5	1,8	8,5	3' 3 3/8"	27' 10 5/8"	0.07	91	40

TECHNICAL DATA

Properties	standard	value	USC conversion
Thickness	-	1,8 mm	0.07 in
Surface mass m	-	1 kg/m ²	0.20 lb/sft
Density ρ	-	approx. 555 kg/m ³	34.6 lb/ft ³
Water vapour transmission Sd	EN 12086	≥ 150 m	≤ 0.023 US perm
Soundproofing of reflected RWS noise	EN 16205	23 sones	-
Compression strength CS	EN 826	300 kPa	-
CREEP viscous sliding under compression CC (10 kPa)	EN 1606	< 0,5 mm	-
Dynamic load resistance DL ₂₅	EN 13793	100000 cycles	-
Thermal resistance R _t	-	0,01 m ² K/W	-
Impact resistance (Large ball test) RLB ⁽¹⁾	EN 13329	< 600 mm	-
Reaction to fire	EN 13501-1	Bfl-s1 class	-
VOC emission classification	French decree no. 2011-321	A+	-

⁽¹⁾Under 7 mm (0.28 inch) laminate.

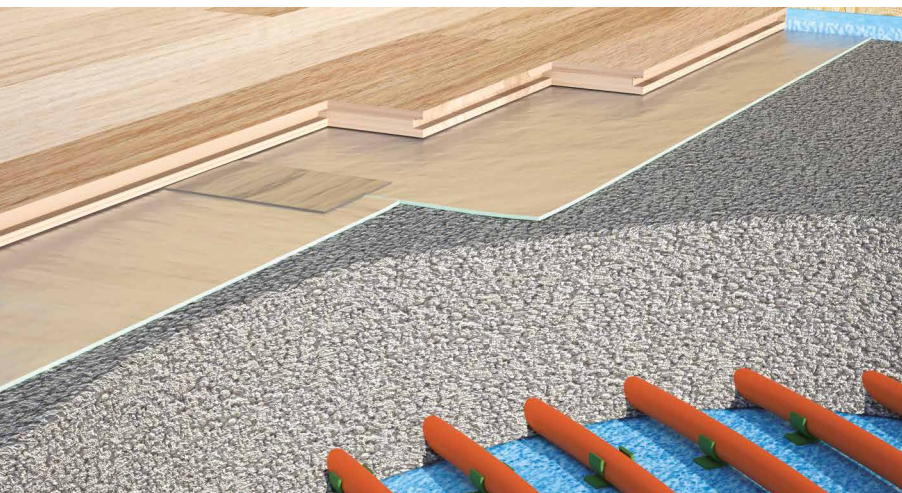

FIELDS OF APPLICATION

FLOOR INSTALLATION

- ✓ floating (not glued)

FLOOR TYPE

- ✓ parquet
- ✓ LVT (medium high quality)
- ✓ laminate

IN-FLOOR HEATING

- ✓ suitable

PIANO A

RESILIENT SOUNDPROOFING PROFILE



LIGHTWEIGHT FLOORS

The profile, thanks to its low dynamic stiffness and the fact that it can be divided into two thinner sizes, proves effective in reducing vibrations even in floors with little mass.

ACOUSTIC PERFORMANCE TESTED

The profile was tested in combination with the ribbing strips of the light-weight floors, resulting in an improvement of up to 7dB.

CODES AND DIMENSIONS

CODE	B [mm]	L [m]	s [mm]	B [in]	L [ft]	s [in]	pcs
PIANO A4040	80	10	6	3' 1/8"	33	1/4	1
PIANO A5050	100	10	6	4	33	1/4	1
PIANO A6060	120	10	6	4' 3/4"	33	1/4	1
PIANO A140	140	10	6	5' 1/2"	33	1/4	1

For more information about the product see page 109.

IMPACT NOISE LEVEL MEASUREMENTS

PIANO A is a resilient profile that works with low loads, which is why its effectiveness was also tested as a separating profile for dry floor ribs at the University of Innsbruck.

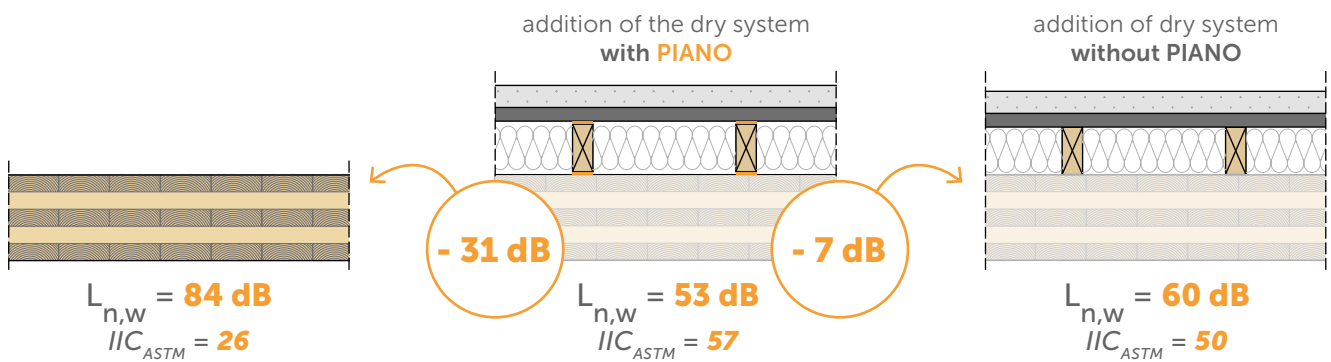

Graphs and frequency values available. See the manual for more information on configuration.



COMPLETE RANGE

Different versions are available to cover a wide load range: from floating floors to multi-storey buildings.

ANTI-VIBRATION SUPPORT

Easily cut for use as a PAD under raised floors and point elements.

SILENT UNDERFLOOR

RESILIENT STRIP FOR FLOOR UNDERBATTENS AND SUPPORTING WALLS

PRACTICAL

Easy to apply adhesive Strip, also with the aid of LIZARD unwinder.

SMART

While acoustically decoupling the ribs of the substructure of a counter-wall, it also acts as a nail sealing tape at the perforations.



CODES AND DIMENSIONS

CODE	B [mm]	L [m]	s [mm]	B [in]	L [ft]	s [in]	
SILENTUNDER50	50	30	4	2"	98' 5 1/8"	0.16	5

TECHNICAL DATA

Properties	standard	value	USC conversion
Thickness	-	4 mm	0.16 in
Surface mass m	-	0,56 kg/m ²	0.12 lb/sft
Density ρ	ISO 845-95	140 kg/m ³ ±15%	8.7 lb/ft ³
Water absorption	ASTM D1056-00	< 10%	-
Tear strength	ISO 1798-7	> 400 kN/m ²	-
Elongation at failure	ISO 1798-7	> 180%	-
Compression strength	ASTM D1056	25% compression: 40 kPa 50% compression: 105 kPa	-
Increase of sound reduction index ΔR _w ⁽¹⁾	ISO 10140-2	4 dB	-
UV-resistant	-	excellent	-
Resistance to temperature	-	-40 / +90 °C	-40 / +194 °F

⁽¹⁾Measured in the laboratory on 100 mm (3 7/8") CLT wall. See the manual for more information on configuration.

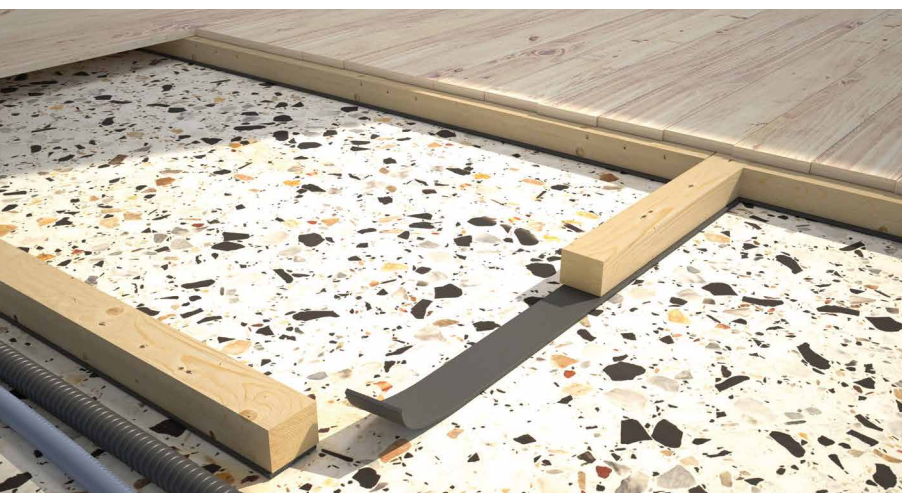

PERFORMANCE

Increase of sound insulation

$$\Delta R_w = 4 \text{ dB}$$

See the manual for more information on configuration.



MATERIAL

Expanded EPDM with acrylic glue and silicone paper liner. Does not contain harmful substances.

GRANULO

RESILIENT GRANULAR RUBBER SOUNDPROOFING PRODUCT

THREE FORMATS

Available in sheet (GRANULOMAT 1,25 x 10 m), roll (GRANULOROLL and GRANULO100) or pad (GRANULOPAD 8 x 8 cm). Extremely versatile thanks to the variety of formats.

TESTED

GRANULO has been tested as a separating product under raised floors, even in working environments where high acoustic performance is required.

CODES AND DIMENSIONS

CODE	B	L	s	B	L	s	pcs
	[mm]	[m]	[mm]	[in]	[ft]	[in]	
GRANULO100	100	15	4	4	9/16	3/16	1
GRANULOPAD	80	0,08	10	3 1/8	3 1/8	3/8	20
GRANULOROLL	80	5	8	3 1/8	19.7	5/16	1
GRANULOMAT	1250	10	6	49 3/16	33	1/4	1



LABORATORY TESTING

GRANULO was tested within the experimental campaign of the BIGWOOD research project in combination with solutions for inspectable floors.

8 configurations tested with GRANULO proven effectiveness

The data are published at www.bigwood.projects.unibz.it.

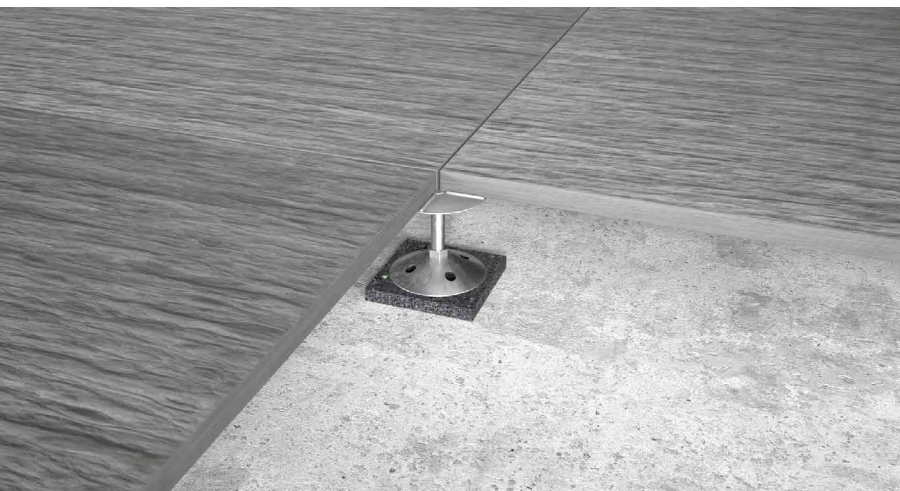

ANTI-VIBRATION

The thermal-bonded rubber granules dampen vibrations, thus insulating the noise produced by footsteps. Also ideal as a wall barrier and resilient strip for acoustic separation.

VERSATILE

Ideal as a substrate for timber, aluminium, WPC and PVC structures. It can also be used outdoors.

STRIPS | Recommendations for installation

APPLICATION WITH PRIMER SPRAY



APPLICATION WITH DOUBLE BAND



PAD | Recommendations for installation

APPLICATION UNDER BATTENS



APPLICATION UNDER RAISED FLOOR

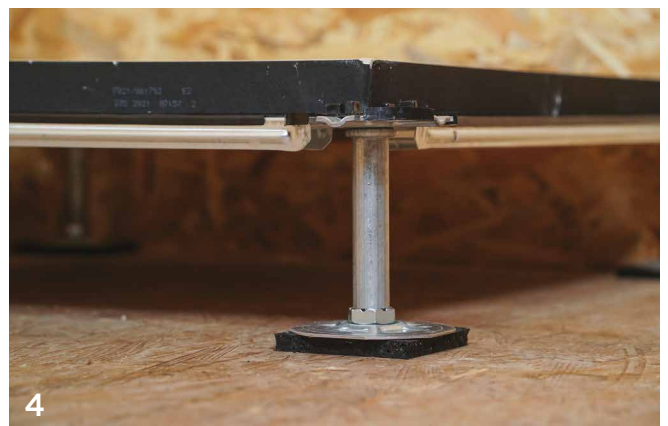

AIRBORNE NOISE

AIRBORNE NOISE

| AIRBORNE NOISE

SILENT WALL BYTUM SA <i>SOUNDPROOFING AND WATERPROOFING SELF-ADHESIVE BITUMINOUS MEMBRANE</i>	60
SILENT WALL BYTUM <i>SOUNDPROOFING AND WATERPROOFING BITUMINOUS MEMBRANE</i>	62
SILENT GIPS <i>THERMAL-ACOUSTIC DECOUPLING TAPE FOR PLASTERBOARD STRUCTURES</i>	65
GIPS BAND <i>SINGLE-SIDED NAIL POINT SEALANT TAPE</i>	66
CONSTRUCTION SEALING <i>COMPRESSIBLE SEALING GASKET FOR REGULAR JOINTS</i>	67
TRASPIR METAL <i>3D MATS FOR METAL ROOFS</i>	70

WALL ACOUSTIC PROBLEMS



WHAT IS AIRBORNE NOISE?

Airborne noise is a set of sound waves that originates in the air and is then transmitted into adjacent rooms either by air or by structure. This is the main problem to be solved when designing vertical partitions in buildings.

AIRBORNE NOISE TRANSMISSION AND POSSIBLE SOLUTIONS

The purpose of soundproofing measures is to minimise the transmission of sound from one room to another.

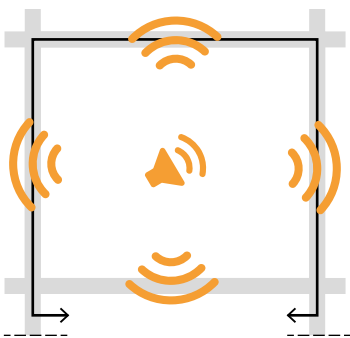

Airborne noise is transmitted to adjacent rooms either by air or by structure, following the paths represented by the arrows (lateral transmission see page 84).



The floor assembly reduces noise propagation through the ceiling (see page 22). The use of resilient decoupling profiles reduces the propagation of airborne and structural noise (see page 86).



The correct design of partition walls and of any false ceilings makes it possible to attenuate all types of noise propagation by preventing the transmission of airborne noise generated in the environment.

HOW DO YOU MEASURE SOUND REDUCTION INDEX?

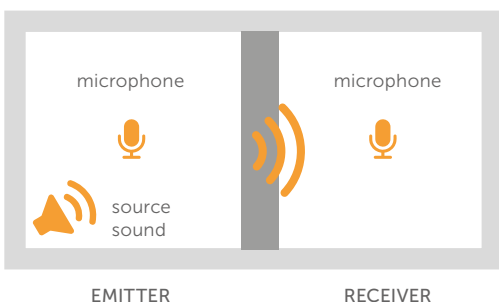

The measurement is performed by activating a specific noise source in the emitting environment and measuring the sound pressure levels in both environments (emitter and receiver). The sound reduction index is given by the difference of the two measured levels. Therefore, the higher the R_w value, the better the acoustic performance of the construction assembly.

SOUND REDUCTION INDEX... WHAT DOES IT MEAN "IN PRACTICE"?

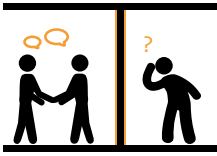

Sound reduction index is the ability to reduce noise transmission between one room and another. Sound insulation allows noise thresholds to be controlled and makes the building pleasant and comfortable.

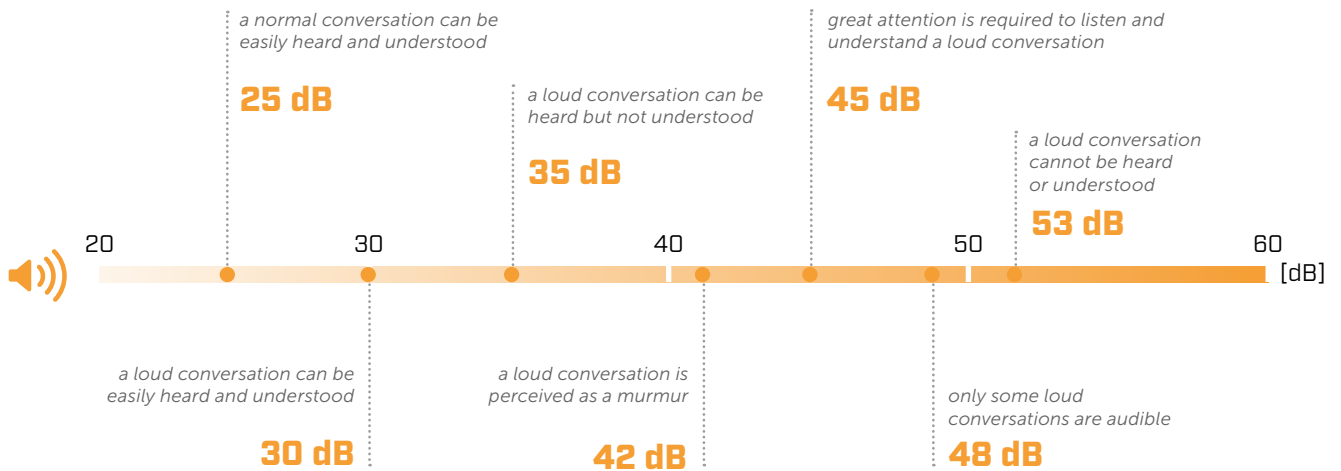

SOUND REDUCTION INDEX R VS APPARENT SOUND REDUCTION INDEX R'

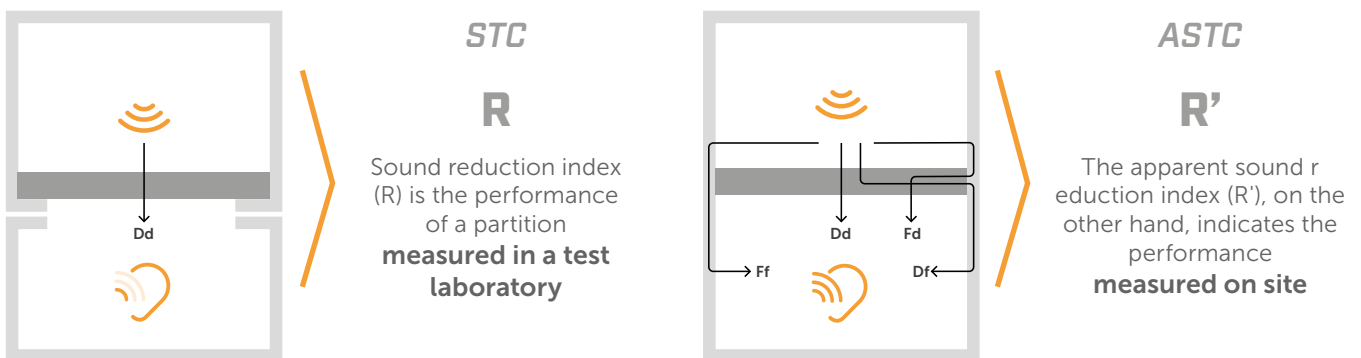

The acoustic laboratories are constructed in such a way that the chambers are completely decoupled from each other, so that lateral transmissions are completely eliminated. **For the same construction assembly and installation, the performance measured in the laboratory will therefore be better than the performance measured on site.**

IMPORTANCE OF DETAILS

In acoustic design, as in other fields, the design and correct implementation of details is very important. It is counter productive to design a high-performing construction assembly if discontinuities are neglected (holes, structure-to-doors/windows connection, wall intersections, etc.).

Best practice that: **to increase the sound reduction index of a wall constructed of several elements, the sound reduction index of the weakest element should be increased.**



R_w vs STC

STC stands for Sound Transmission Classification. It indicates the sound reduction index of a construction assembly by evaluating sound sources with frequencies between 125 and 4000 Hz. The higher the number, the better the performance.

SILENT WALL

SOLUTIONS FOR AIRBORNE NOISE

TESTED RESULTS AND FAST DRY INSTALLATION

The entire range of soundproofing membranes ensures good acoustic performance even when installed dry and without invasive intervention.

Developed in different versions and with different materials from bitumen to polyethylene, the membranes offer high soundproofing properties and are lead free. Some of these are equipped with an adhesive surface to facilitate installation even on floors or suspended ceilings.

The products have been tested and provide soundproofing increase of up to 5 dB.

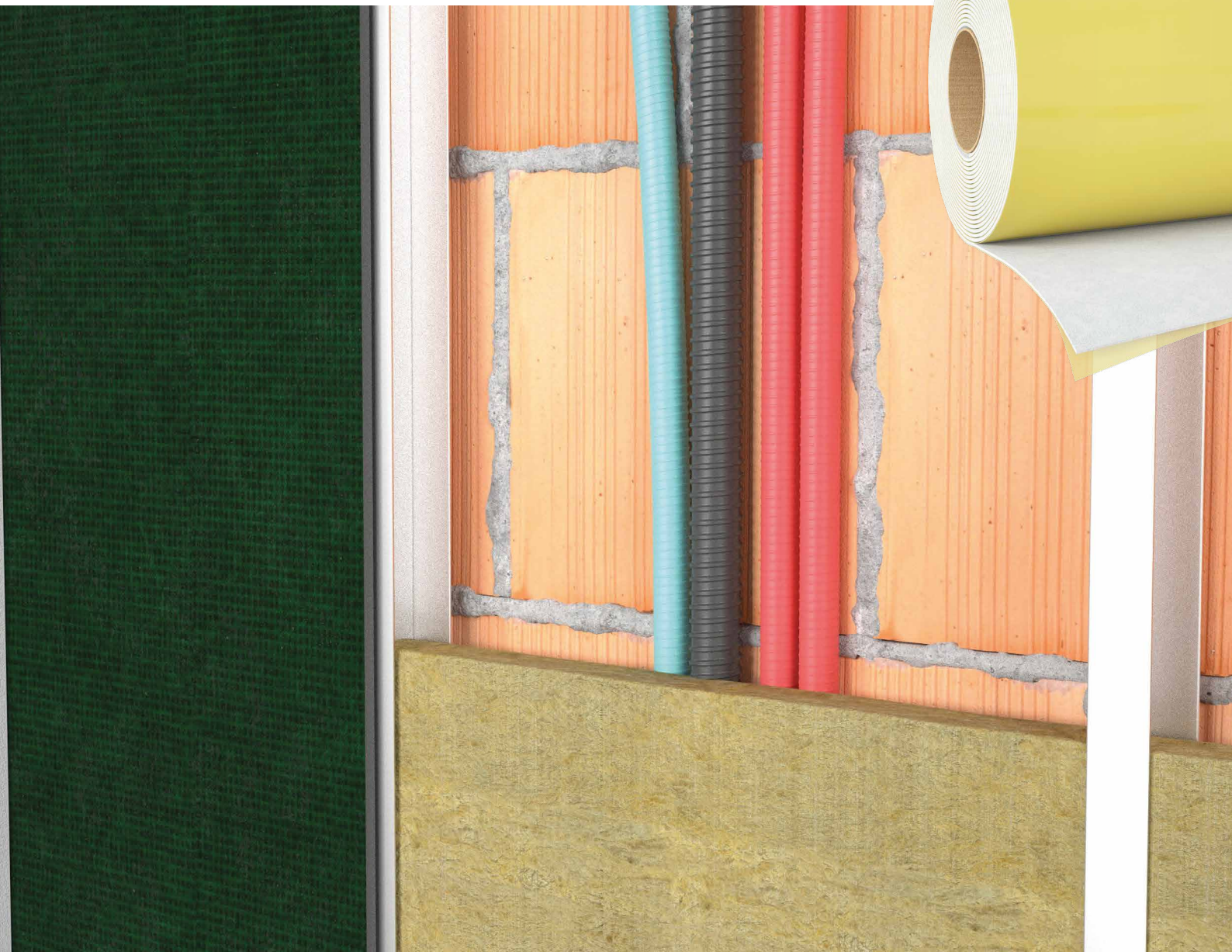
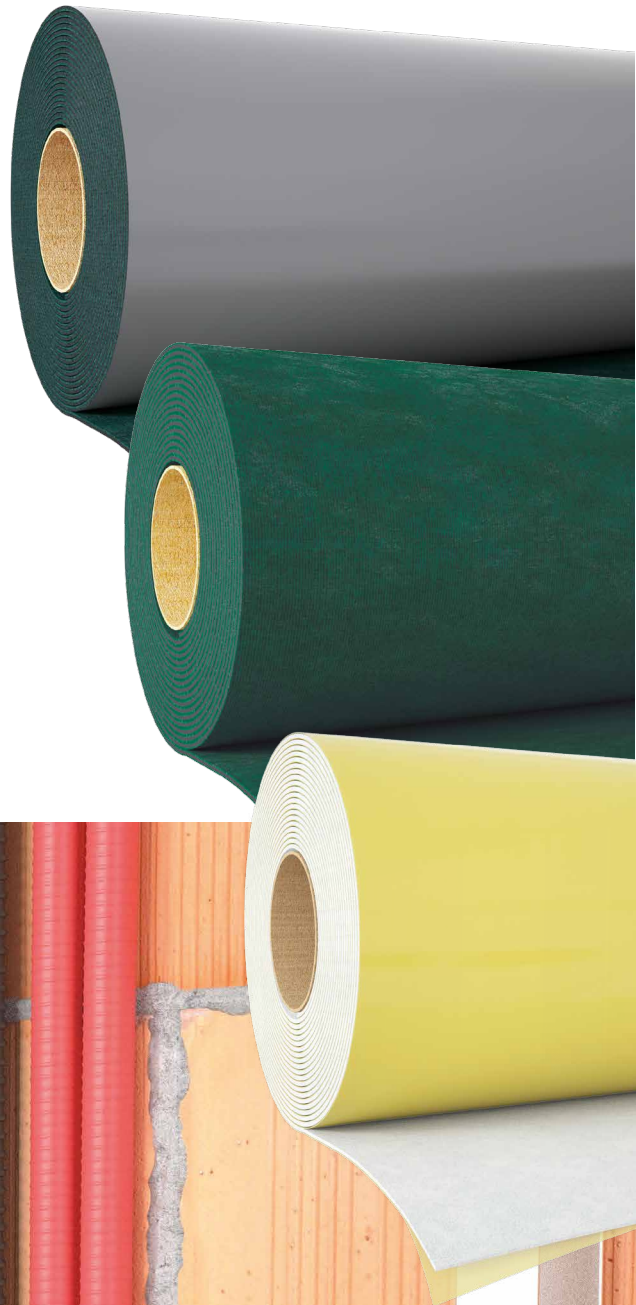

CODES AND DIMENSIONS

SILENT WALL BYTUM SA

CODE	H	L	s	A	H	L	s	A	
	[m]	[m]	[mm]	[m ²]	[ft]	[ft]	[in]	[ft ²]	
SILWALLSA	1	8,5	4	8,5	3' 3 3/8"	27' 10 5/8"	0.16	91	24

SILENT WALL BYTUM

CODE	H	L	s	A	H	L	s	A	
	[m]	[m]	[mm]	[m ²]	[ft]	[ft]	[in]	[ft ²]	
SILWALL	1,2	5	4,2	6	3' 3 3/8"	16' 4 7/8"	0.17	65	30

SILENT WALL SURFACE

CODE	H	L	s	A	H	L	s	A	
	[m]	[m]	[mm]	[m ²]	[ft]	[ft]	[in]	[ft ²]	
SILWALLSUR	-	-	-	-	-	-	-	-	-

See website www.rothoblaas.com.



PRODUCT COMPARISON



SILENT WALL BYTÜM



SILENT WALL BYTÜM SA



SILENT WALL SURFACE

	SILENT WALL BYTÜM	SILENT WALL BYTÜM SA	SILENT WALL SURFACE
integrated adhesive strip	-	✓	✓
thickness	4,2 mm 0.17 in	4,0 mm 0.16 in	3,0 - 30,0 mm 0.12 in - 1.18 in
mass	6 kg/m² 1.2 lbf/ft ²	5 kg/m² 1.0 lbf/ft ²	20-50 kg/m² 1.2 lbf/ft ² - 3.1 lbf/ft ²
acoustic values	$\Delta R_w = +8$ dB soundproofing by mass addition	$\Delta R_w = +8$ dB soundproofing by mass addition	- see website www.rothoblaas.com
material	bitumen	bitumen	polyester felt
indoor use	✓	✓	✓
outdoor use	✓	✓	-
airborne noise	✓	✓	✓
reverberation	-	-	✓

SILENT WALL BYTUM SA

SOUNDPROOFING AND WATERPROOFING SELF-ADHESIVE BITUMINOUS MEMBRANE

NOISE REDUCTION

Due to its high surface mass (5 kg/m²), the membrane absorbs up to 27 dB. Also tested in different configurations at the University of Bolzano.

SELF-ADHESIVE

Thanks to its self-adhesive side, installation of the membrane is fast and precise in both horizontal and vertical applications and without mechanical fastening.

PRACTICAL

The pre-cut removable film makes the sound-insulating membrane easier to install.

COMPOSITION

non-woven polypropylene fabric

waterproofing membrane made of elastoplastomeric bitumen

adhesive

removable silicone film

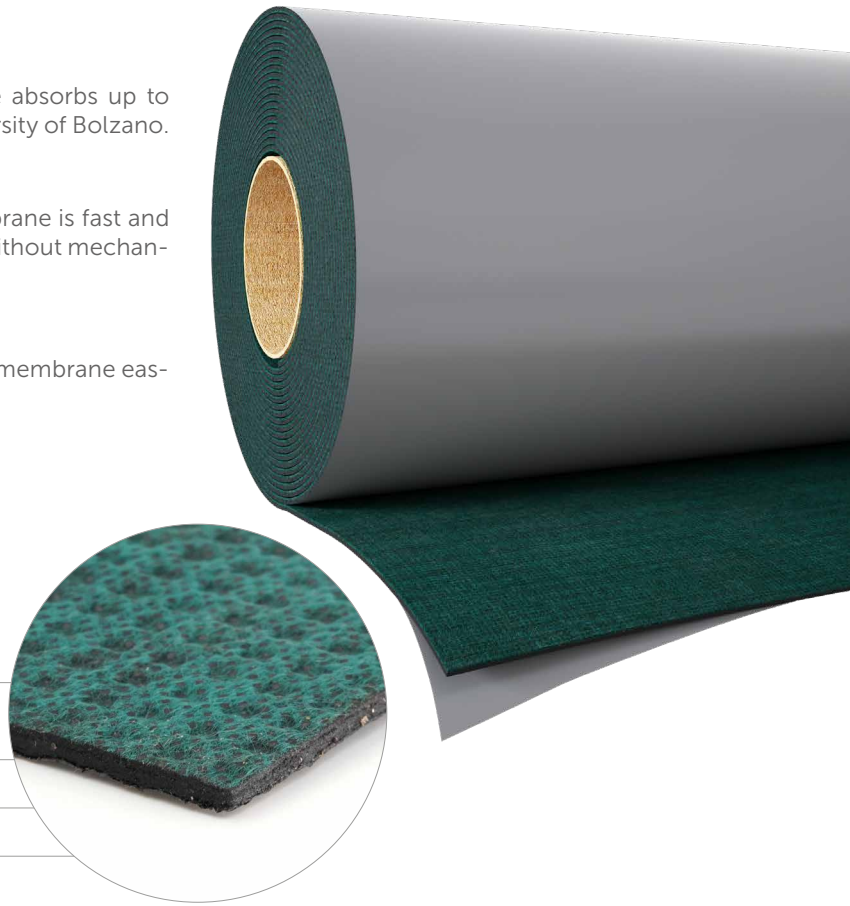

CODES AND DIMENSIONS

CODE	H	L	thickness	surface mass	A	H	L	thickness	surface mass	A	
	[m]	[m]	[mm]	[kg/m ²]	[m ²]	[ft]	[ft]	[in]	[lb/sft]	[ft ²]	
SILWALLSA	1	8,5	4	5	8,5	3' 3 3/8"	27' 10 5/8"	0.16	1.02	91	24

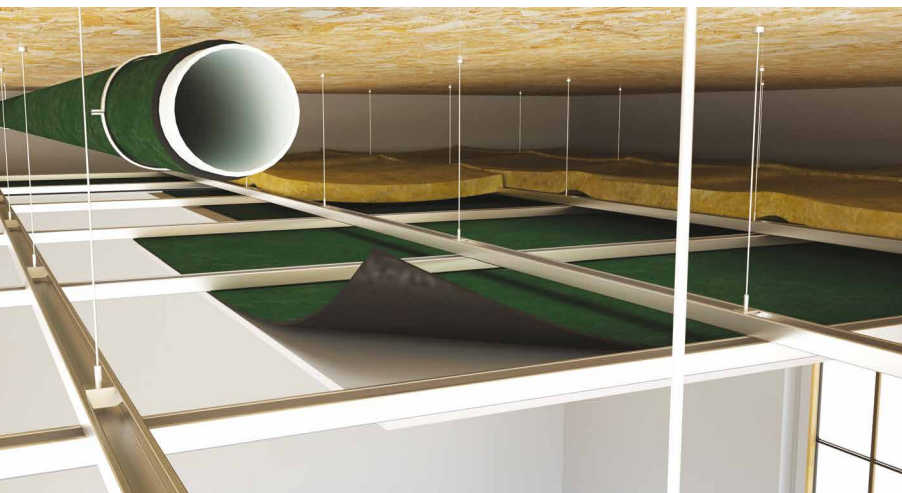

HERMETIC

Watertight and airtight, sealing of penetrations for mechanical fasteners is not required.

WITHOUT LEAD

Made of self-adhesive elastoplastomeric bitumen, it does not contain lead or harmful substances.

TECHNICAL DATA

Properties	standard	value	USC conversion
Thickness	-	4 mm	0.16 in
Surface mass m	-	5 kg/m ²	1.02 lb/ft ²
Density ρ	-	1250 kg/m ³	78.03 lb/ft ³
Resistance to airflow r	ISO 9053	> 100 kPa·s·m ⁻²	-
Critical frequency	-	> 85000 Hz	-
Increase of sound reduction index ΔR _w ⁽¹⁾	ISO 10140-2	4 dB	-
Vibration damping - loss factor η (200 Hz)	ASTM E756	0,26	-
Thermal resistance R _t	-	0,023 m ² K/W	-
Thermal conductivity λ	-	0,17 W/m·K	0.098 BTU/(h·ft ² ·°F)
Specific heat c	-	1200 J/kg·K	0.29 BTU/(lb·°F)
Water vapour resistance factor μ	EN 12086	100000	2000 MN·s/g
Water vapour transmission Sd	-	approx. 400 m	ca. 0.009 US perm
Reaction to fire	EN 13501-1	class E	-

⁽¹⁾ Measured in the laboratory on a 170 mm (6 3/4") timber-framed wall. See the manual for more information on configuration.

✓ SOUND REDUCTION INDEX LEVEL MEASUREMENTS

Tests carried out in the laboratory of the **University of Padua** in accordance with EN ISO 10140-2 have made it possible to measure the sound reduction index of the construction assembly described below:

- ① plasterboard panel (s: 12,5 mm - 0.5 in)
- ② **SILENT WALL BYTUM SA** (s: 4 mm - 0.16 in)
- ③ plasterboard panel (s: 12,5 mm - 0.5 in)
- ④ solid wood batten (s: 60 mm - 2.4 in)
- ⑤ low density mineral wool insulation (s: 60 mm - 2.4 in)
- ⑥ CLT panel (s: 100 mm - 3.9 in)
- ⑦ low density mineral wool insulation (s: 60 mm - 2.4 in)
- ⑧ solid wood batten (s: 60 mm - 2.4 in)
- ⑨ plasterboard panel (s: 12,5 mm - 0.5 in)
- ⑩ **SILENT WALL BYTUM SA** (s: 4 mm - 0.16 in)
- ⑪ plasterboard panel (s: 12,5 mm - 0.5 in)

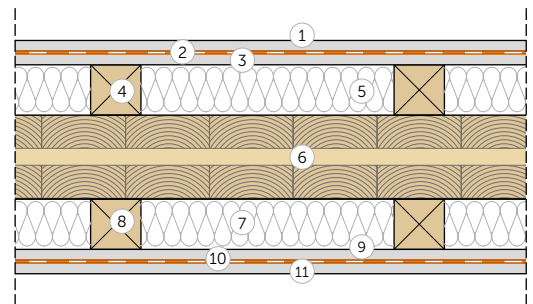

graphs and frequency values available

See the manual for more information on configuration

$$R_w (C; C_{tr}) = 59 (-2; -7) \text{ dB}$$

Use the QR-code to download
the complete manual!

www.rothoblaas.com



SILENT WALL BYTUM

SOUNDPROOFING AND WATERPROOFING BITUMINOUS MEMBRANE

TESTED

Thanks to its high surface mass (6 kg/m²), excellent reduction of airborne noise transmission can be achieved with minimal thicknesses. Also tested at the University of Bolzano.

PRACTICAL

Mechanical fastening allows the membrane to be applied to any surface, compensating for irregularities.

COST-PERFORMANCE

Composition of the mixture optimised to provide both good performance and low cost.

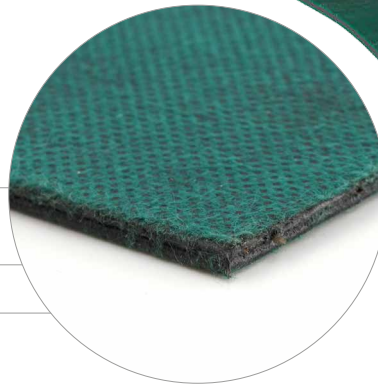
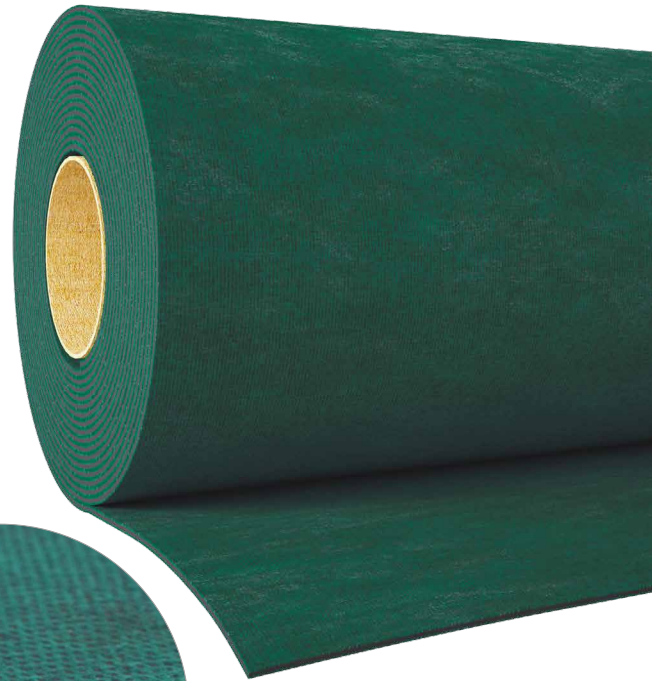

COMPOSITION

non-woven polypropylene fabric

waterproofing membrane made of elastoplastomeric bitumen

non-woven polypropylene fabric

CODES AND DIMENSIONS

CODE	H	L	thickness	surface mass	A	H	L	thickness	surface mass	A	
	[m]	[m]	[mm]	[kg/m ²]	[m ²]	[ft]	[ft]	[in]	[lb/sft]	[ft ²]	
SILWALL	1,2	5	4,2	6	6	3' 3 3/8"	16' 4 7/8"	0.17	1.23	65	30



VERSATILE

For any application where an increase in mass is required.

SAFE

Made of elastoplastomeric bitumen, covered on both sides with a polypropylene non-woven fabric. Does not contain harmful substances.

TECHNICAL DATA

Properties	standard	value	USC conversion
Thickness	-	4,2 mm	0.17 in
Surface mass m	-	6 kg/m ²	1.23 lb/ft ²
Density ρ	-	1500 kg/m ³	93.64 lb/ft ³
Resistance to airflow r	ISO 9053	> 100 kPa·s·m ⁻²	-
Compressibility class	EN 12431	class CP2	-
CREEP viscous sliding under compression (1.6 kPa - 33.4 psf)	EN 1606	0,5 %	-
Increase of sound reduction index ΔR _w ⁽¹⁾	ISO 10140-2	4 dB	-
Vibration damping - loss factor η (200 Hz)	ASTM E756	0,25	-
Thermal resistance R _t	-	0,1 m ² K/W	-
Thermal conductivity λ	-	0,7 W/m·K	0.404 BTU/(h·ft ² ·°F)
Specific heat c	-	900 J/kg·K	0.22 BTU/(lb·°F)
Water vapour resistance factor μ	EN 12086	20000	420 MN·s/g
Water vapour transmission Sd	-	80 m	0.043 US perm
Reaction to fire	EN 13501-1	class E	-

⁽¹⁾Measured in the laboratory on a 170 mm (6 3/4") timber-framed wall. See the manual for more information on configuration.

✓ SOUND REDUCTION INDEX LEVEL MEASUREMENTS

Tests carried out in the **Building Envelope Lab** of the **Free University of Bozen/Bolzano** in accordance with EN ISO 10140-2 have made it possible to measure the impact noise level of the construction assembly described below:

BASIC CONFIGURATION:

- ① timber frame structure (s: 170 mm - 6.7 in)
- ② plasterboard panel (s: 12,5 mm - 0.5 in)

$$R_w = 48 \text{ dB}$$

$$STC_{ASTM} = 48$$

CONFIGURATION 1:

- ① timber frame structure (s: 170 mm - 6.7 in)
- ② 2x plasterboard panel (s: 12,5 mm - 0.5 in)

$$R_w = 52 \text{ dB}$$

$$STC_{ASTM} = 53$$

+2,5 cm

$$\Delta R_w = +4 \text{ dB}$$

CONFIGURATION 2:

- ① timber frame structure (s: 170 mm - 0.5 in)
- ② **SILENT WALL BYTUM** (s: 4,2 mm - 0.17 in)
- ③ plasterboard panel (s: 12,5 mm - 0.5 in)

$$R_w = 53 \text{ dB}$$

$$STC_{ASTM} = 50$$

+0,8 cm

$$\Delta R_w = +5 \text{ dB}$$

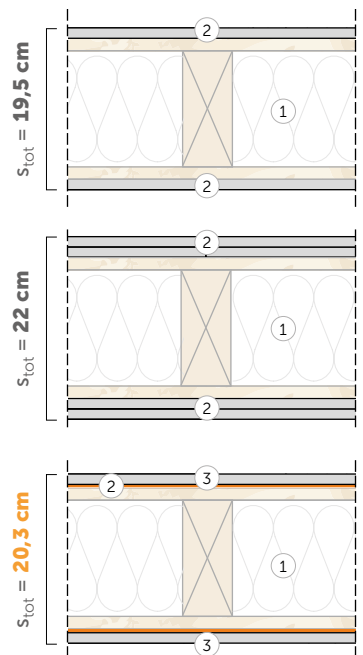

By using SILENT WALL BYTUM you can save space and achieve better results.

graphs and frequency values available

See the manual for more information on configuration

Use the QR-code to download the complete manual!

www.rothblaas.com



SILENT WALL | Recommendations for installation

SILENT WALL BYTUM SA



SILENT WALL BYTUM



SILENT GIPS

THERMAL-ACOUSTIC DECOUPLING TAPE FOR PLASTERBOARD STRUCTURES

DECOUPLING

It allows complete acoustic decoupling of the plasterboard wall, preventing the transmission of vibrations to structural elements. Also tested at the University of Bolzano.

DOUBLE-SIDED ADHESIVE

Installation with the metal frame is fast and easy, without the need for additional adhesives.



CODES AND DIMENSIONS

CODE	B	liner	L	s	B	liner	L	s	
	[mm]	[mm]	[m]	[mm]	[in]	[in]	[ft]	[in]	
SILENTGIPS	100	12-76-12	30	3,3	3 7/8"	1/2"-3"-1/2"	98' 5 1/8"	0.13	1

TECHNICAL DATA

Properties	standard	value	USC conversion
Thickness	-	3,3 mm	0.13 in
Density ρ	-	150 kg/m ³	9.36 lb/ft ³
Dynamic stiffness s'	EN 29052	60 MN/m ³	-
Crushing (load 6,5 kPa - 135 psf)	ISO 7214	0,3 mm	0.01 in
Thermal conductivity λ	EN 12667	0,04 W/m·K	0.023 BTU/(h·ft ² ·°F)
Thermal resistance R_t	ISO 6946	0,08 m ² K/W	-
Resistance to temperature	-	-20 / +80 °C	-4 / +176 °F



CLOSED CELL

Thanks to the grid of closed cell polyethylene, the product will not permanently deform and remains effective over time.

VERSATILE

The pre-cut removable film allows the tape to be adapted to different plasterboard wall configurations.

GIPS BAND

SINGLE-SIDED NAIL POINT SEALANT TAPE



TESTED

It can be used simultaneously as an acoustic decoupling and as self-sealing tape around the nails for the ribs of the counter-wall structure. Also tested in different configurations at the Universities of Bolzano and Padua.

HERMETIC

Specifically for rain and airtight sealing of penetration points of nails and screws. Thanks to its closed-cell structure, it is waterproof even when trimmed or perforated.

CODES AND DIMENSIONS

CODE	B [mm]	s [mm]	L [m]	B [in]	s [in]	L [ft]	
GIPSBAND50	50	3	30	2"	0.12	98' 5 1/8"	10

TECHNICAL DATA

Properties	standard	value	USC conversion
Thickness	-	3 mm	0.12 in
Density ρ	-	approx. 25 kg/m ³	1.56 lb/ft ³
Tear strength MD/CD	ISO 1926	325/220 kPa	-
Elongation MD/CD	ISO 1926	125/115 %	-
Compression strength	ISO 3386/1	10%: 2 kPa 25%: 3 kPa 50%: 5 kPa	-
Reaction to fire	EN 13501-1	class E	-
	DIN 4102-1	class B2	-
Water absorption	ISO 2896	< 2% vol.	-
Thermal conductivity λ	-	0,04 W/(m·K)	0.023 BTU/(h·ft ² ·°F)
Solvents	-	no	-
Storage temperature	-	+5 / +25 °C	+41 / +77 °F
Resistance to temperature	-	-30 / +80 °C	-22 / +176 °F



PERFORMANCE

Increase of sound insulation

$$\Delta R_w = +4 \text{ dB}$$

See the manual for more information on configuration.





CONSTRUCTION SEALING

COMPRESSIBLE SEALING GASKET FOR REGULAR JOINTS

NOISE REDUCTION

The acoustic performance has been tested in the Flanksound Project by Rothoblaas: using it as a wall isolation gasket provides up to 3 dB of noise reduction.

PRACTICAL

Sealing of timber to timber joints can be carried out on site or during prefabrication.



CODES AND DIMENSIONS

CODE	B	s	L	B	s	L	
	[mm]	[mm]	[m]	[in]	[in]	[ft]	
CONSTRU4625	46	3	25	1 3/4"	0.12	82' 1/4	3

TECHNICAL DATA

Properties	standard	value	USC conversion
Thickness	-	3 mm	0.12 in
Density ρ	-	approx. 0,48 g/cm ³	29.97 lb/ft ³
Compression deformation 22h +23 °C (73°F)	EN ISO 815	< 25%	-
Compression deformation 22h +40 °C (104°F)	EN ISO 815	< 35%	-
Correction of K_{ij} in the presence of elastic profile in the joint $\Delta_{l,ij}$ ⁽¹⁾	ISO 10848-1	4 dB	-
Solvents	-	no	-
Storage temperature	-	+5 / +25 °C	+41 / +77 °F
Resistance to temperature	-	-35 / +100 °C	-31 / +212 °F

⁽¹⁾Measurement performed during the Flanksound Project. See the manual for more information on configuration.

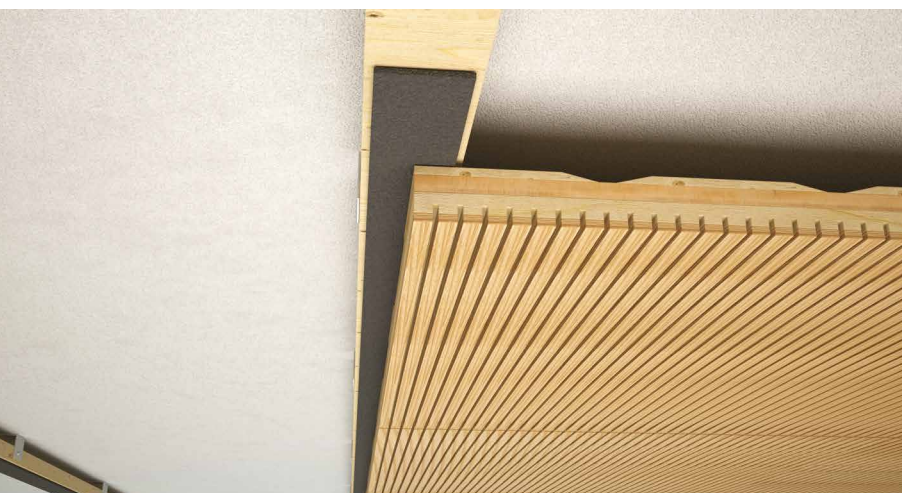

PERFORMANCE

Increase of sound insulation

$$\Delta_{l,ij} = 4 \text{ dB}$$

$$\Delta_{l,ij} = K_{ij,with} - K_{ij,without}$$

See the manual for more information on configuration.



SOUND ABSORPTION



WHAT IS REVERBERATION?

Reverberation is a phenomenon that occurs inside a closed room when sound waves, generated by a source, are reflected in a disordered manner and for a long period by the walls, even when the sound source has stopped producing them.

HOW DO I SOLVE IT

Designing spaces correctly by means of sound absorption means being able to minimise sound wave reflections within rooms, using specific solutions or products capable of absorbing a large amount of them.

very reverberant environment

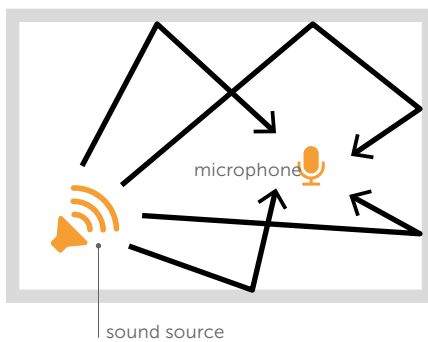

In this image, we note that sound bounces off surfaces and therefore reverberation will be easily perceived.

acoustically corrected environment

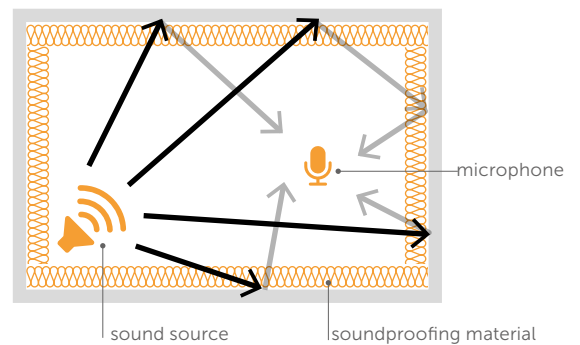

In this image, however, we see that, thanks to a sound-absorbing intervention, the sound impacting the wall decreases drastically.

SOUND ABSORPTION

Sound-absorbing materials are those that can dissipate the energy of incident sound waves on the surface, due to their porous nature. Sound-absorbing materials of a fibrous nature, such as SILENT WALL SURFACE, are able to prevent the reflection of sound waves in favour of an effective absorption of the waves, thanks to the convective motions generated in the cavities between the fibres.

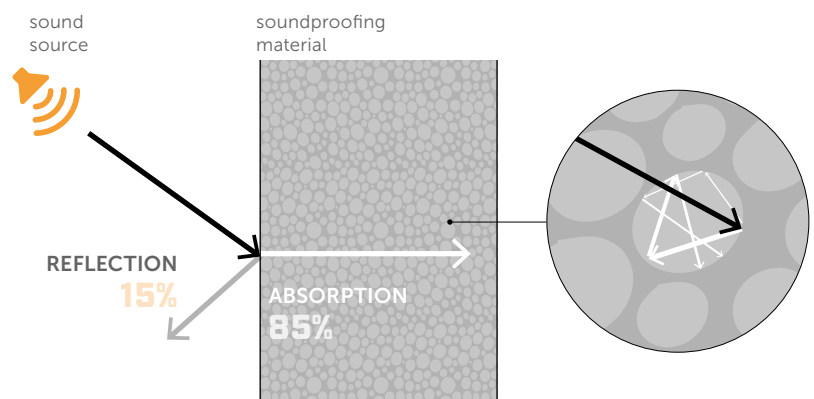

WE WILL TELL YOU ABOUT OUR SILENCE



Acoustic well-being within a building comes from careful design and the choice of efficient materials. Sound-absorbing products reduce background noise in living spaces and have thermal-acoustic functions. When coupled with interior ceiling or wall coverings, they significantly reduce reverberation noise.

SILENT WALL SURFACE by Rothoblaas is the sound-absorbing solution with a fibrous polyester felt structure that can speak silently.

Scan the QR code or visit our website to see what's new!



www.rothoblaas.com



rothoblaas

Solutions for Building Technology

TRASPIR METAL

3D MATS FOR METAL ROOFS



CERTIFIED NOISE REDUCTION

The 3D mats guarantee reduction of airborne and heavy rain noises. Values tested and certified.

PROTECTIVE FELT

The breathable membrane with 3D grid includes a fifth layer that blocks impurities and improves ventilation.

HIGH DENSITY 3D GRID

The 3D mat has high mechanical strength and is also appropriate for aluminium sheet metal.

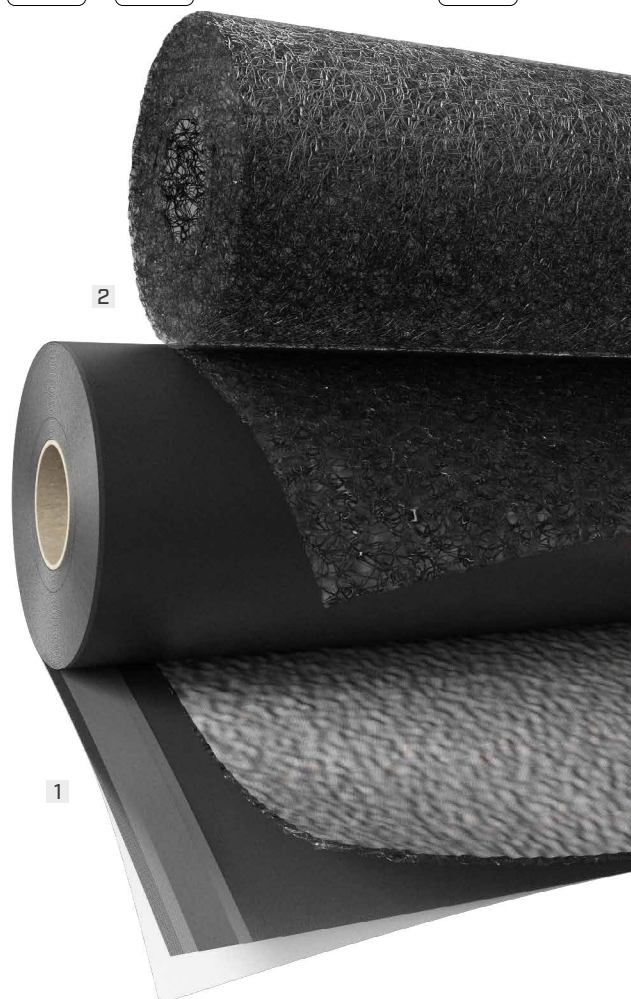

CODES AND DIMENSIONS

CODE	description	tape	H [m]	L [m]	A [m ²]	H [ft]	L [ft]	A [ft ²]	
1 TTTMET610	TRASPIR 3D COAT TT	TT	1,35	33	44,55	4.43	108.27	479.54	4
2 NET350	NET 350	-	1,25	50	62,5	4.11	164	672.75	4

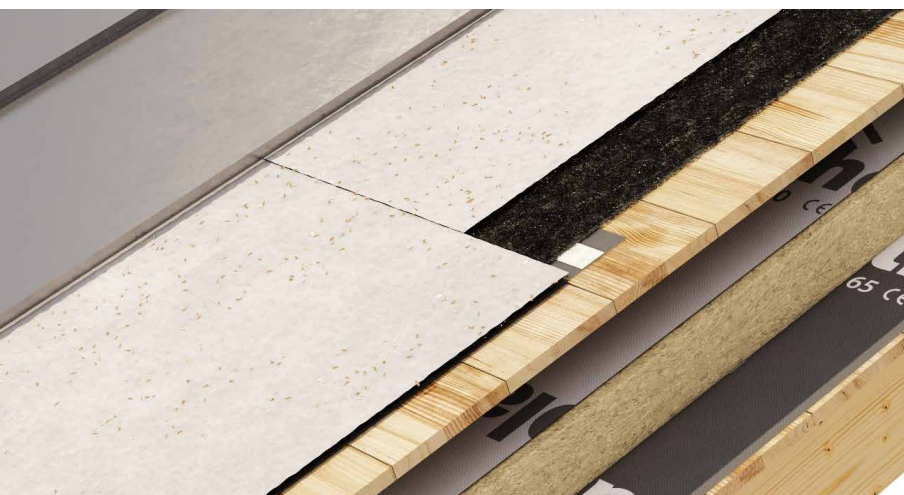

SAFE VENTILATION

The breathable membrane TRASPIR 3D COAT comes with a 3D grid and a protective felt on the surface, that prevents the entry of impurities and improves ventilation.

VERSATILE

Also ideal in combination with BYTUM or TRASPIR to create a micro-ventilation layer in both wall and roof installations.

LABORATORY MEASUREMENTS

emitting room



receiving room

The effectiveness of TRASPIR METAL was demonstrated through an airborne soundproofing test and noise generated by heavy rain.

The chosen construction assembly was tested with and without TRASPIR METAL (sheet metal directly on the board).

reduction of noise from heavy rain **up to 4 dB**

RESULTS	WITHOUT TRASPIR METAL	WITH TRASPIR METAL
AIRBORNE NOISE	$R_w = 43 \text{ dB}$	Increase of sound insulation by 1 dB $R_w = 44 \text{ dB}$
HEAVY RAIN	$L_{IA} = 36,9 \text{ dB}$	Reduction of noise from rain up to 4.2 dB $L_{IA} = 32,7 \text{ dB}$

RECOMMENDATIONS FOR INSTALLATION

TRASPIR 3D COAT



3D NET



TRASPIR 3D COAT TT

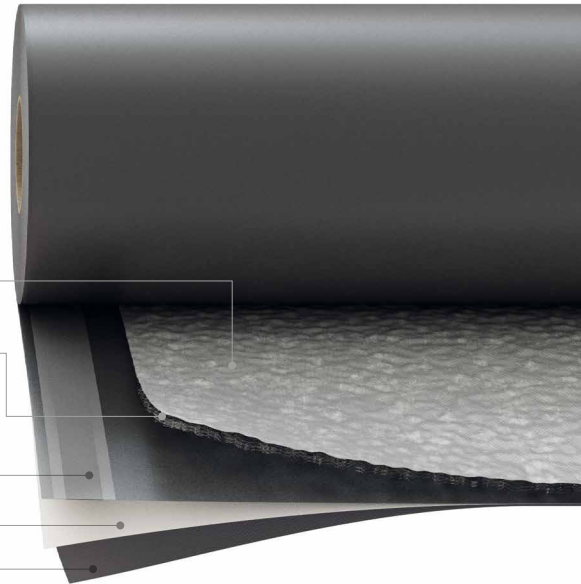

COMPOSITION

protection layer
non-woven PP fabric

middle layer
3-dimensional PP mat

protection layer
non-woven PP fabric

middle layer
PP breathable film

bottom layer
non-woven PP fabric

TECHNICAL DATA

Properties	standard	value	USC conversion
Mass per unit area	EN 1849-2	600 g/m ²	1.97 oz/ft ²
Thickness	EN 1849-2	8 mm	0.315 in
Water vapour transmission (Sd)	EN 1931	0,025 m	139.86 US perm
Tensile strength MD/CD	EN 12311-1	300 / 220 N/50mm	34 / 25 lb/in
Elongation MD/CD	EN 12311-1	> 35 / 50 %	-
Resistance to nail tearing MD/CD	EN 12310-1	150 / 175 N	33.7 / 39.3 lbf
Watertightness	EN 1928	class W1	-
Temperature resistance	-	-40 / 80 °C	-40 / 176 °F
Reaction to fire	EN 13501-1	class E	-
Resistance to penetration of air	EN 12114	< 0,02 m ³ /(m ² h50Pa)	< 0.001 cfm/ft ² at 50Pa
Thermal conductivity (λ)	-	0,3 W/(m·K)	0.17 BTU/h·ft·°F
Specific heat	-	1800 J/(kg·K)	-
Density	-	approx. 75 kg/m ³	approx. 0.04 oz/in ³
Water vapour resistance factor (μ)	-	approx. 33	approx. 0.1 MNs/g
VOC content	-	< 0,02 %	-
UV stability ⁽¹⁾	EN 13859-1/2	3 months	-
Exposure to weather ⁽¹⁾	-	2 weeks	-
Water column	ISO 811	> 250 cm	> 98.4252 in
After ageing:			
- watertightness	EN 1297 / EN 1928	class W1	-
- maximum tensile force MD/CD	EN 1297 / EN 12311-1	> 240 / 155 N/50mm	27 / 22 lb/in
- elongation	EN 1297 / EN 12311-1	> 30 / 40%	-
Flexibility at low temperatures	EN 1109	-40 °C	-22 °F
Void ratio	-	95 %	-
Variation of the sound reduction index ΔR _w	ISO 10140-2 / ISO 717-1	1 dB	-
Variation in overall A-weighted sound intensity level from heavy rain noise ΔL _{iA}	ISO 140-18	approx. 4 dB	-

⁽¹⁾ For the correlation between laboratory tests and actual conditions, see the catalogue "TAPES, SEALANTS AND MEMBRANES" at www.rothoblaas.com.

3D NET



COMPOSITION

3D grid
3-dimensional PP mat

TECHNICAL DATA

Properties	standard	value	USC conversion
Mass per unit area	EN 1849-2	350 g/m ²	1.15 oz/ft ²
Thickness	EN 1849-2	7.5 mm	0.295 in
Maximum tensile force MD/CD NET	EN 12311-1	1,3 / 0,5 N/50mm	0.15 / 0.06 lb/in
Elongation MD/CD NET	EN 12311-1	95 / 65 %	-
Temperature resistance	-	-40 / 80 °C	-40 / 176 °F
Reaction to fire	EN 13501-1	class F	-
Density	-	approx. 35 kg/m ³	approx. 0.02 oz/in ³
VOC emissions	-	< 0,02 %	-
UV stability ⁽¹⁾	EN 13859-1/2	3 months	-
Exposure to weather ⁽¹⁾	-	4 weeks	-
Void ratio	-	95 %	-
Variation of the sound reduction index ΔR_w	ISO 10140-2 / ISO 717-1	1 dB	-
Variation in overall A-weighted sound intensity level from heavy rain noise ΔL_{iA}	ISO 140-18	4 dB	-
Impact sound attenuation index ΔL_w	ISO 140-8	28 dB	-

⁽¹⁾ For the correlation between laboratory tests and actual conditions, see the catalogue "TAPES, SEALANTS AND MEMBRANES" at www.rothoblaas.com.

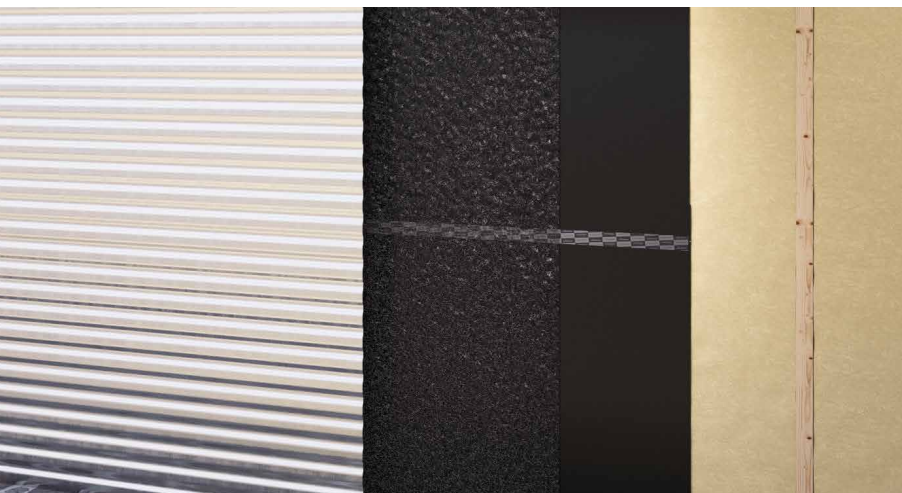

DURABILITY

When installed on a continuous support, it promotes micro-ventilation of metal roofs, preventing corrosion.

ACOUSTIC UPGRADING AND RETROFIT

The objective of a redevelopment is to improve the performance of the building and achieve a better level of comfort. Successful acoustic upgrading requires the services of a competent technician, who generally follows the project procedure indicated below:

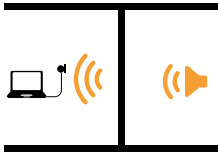

Measurement of sound levels in situ. This step is fundamental in order to be able to identify the building's critical issues and weak points.



Acoustic design. In consideration of the results obtained in the first phase, the designer identifies the necessary retrofits to improve acoustic performance.

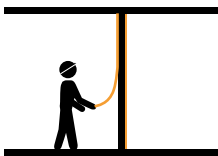

Implementation of the interventions foreseen in the project. Installation and attention to detail is critical.

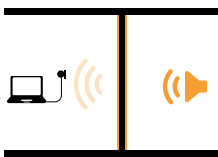

Measurement of sound levels after the retrofit to verify its effectiveness.

Some examples of solutions designed by Rothoblaas to improve the acoustic performance of certain building elements are shown below. The recommended retrofits should not be considered exhaustive of all cases and may not be sufficient to achieve performance goals. The indicated acoustic improvement refers to the tested configuration, which is why Rothoblaas recommends that solutions should always be checked with the acoustic designer.

AIR-TIGHTNESS AND CRITICAL POINTS

Air is an element of noise passage and heat loss. Even the smallest crack allows noise propagation and influences the final performance of the building element.

Restoring the airtightness of the building with the solutions proposed in the chapter "ACOUSTIC and SEALING" is essential to ensure an effective acoustic solution.



Sealing a through gap can produce an improvement of up to **+ 24 dB**.

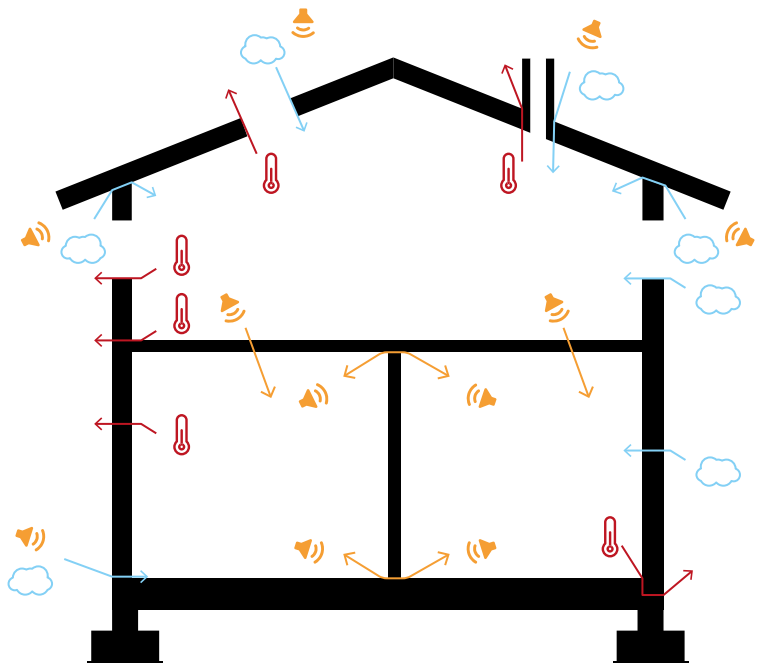

WALL ASSEMBLIES

THIN ACOUSTIC UPGRADES

Bonded coating is a commonly used method for acoustic upgrades because it allows, in just a few centimetres of thickness, a significant improvement in the sound rating of the partition.

Add mass by coupling **SILENT WALL BYTUM** or **SILENT WALL BYTUM SA** to the plasterboard sheet

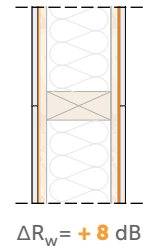
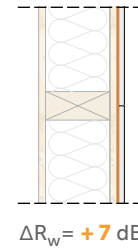

Add a resilient layer **SILENT FLOOR PUR** or **SILENT FLOOR TEX** between the base structure and the plasterboard sheet

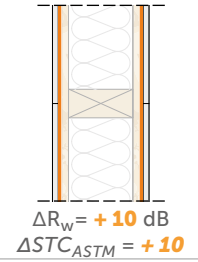
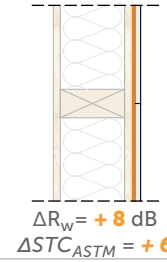

Add strips of resilient layer **PIANO A**, **SILENT FLOOR PUR** in strips and **SILENT FLOOR TEX** in strips and mass by coupling **SILENT WALL BYTUM** or **SILENT WALL BYTUM SA** to the plasterboard sheet

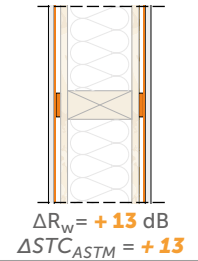
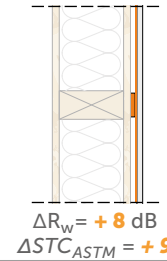

RENOVATION WITH SUPPORTING WALLS

The addition of a supporting wall allows higher performance to be achieved, but requires greater thickness.

Separate the uprights of the supporting wall from the structure with **PIANO A**, **SILENT UNDERFLOOR**, **GEMINI**, **GIPS BAND**, **CONSTRUCTION SEALING** and add mass to the plasterboard sheet with **SILENT WALL BYTUM** or **SILENT WALL BYTUM SA**

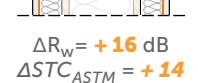
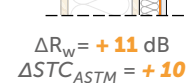

Create a self-supporting structure separated from the structure by at least 1 cm and add mass with **SILENT WALL BYTUM** or **SILENT WALL BYTUM SA** to the plasterboard sheet

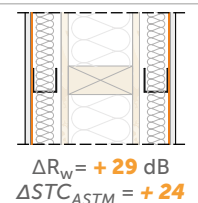
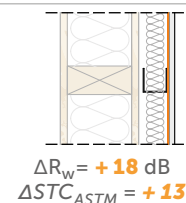

Construction assemblies measured in the laboratory. Frequency data available.

DID YOU KNOW THAT...

The soundproofing of a partition is strongly influenced by the performance of the weakest elements. In façades, it is often the windows and doors that determine the acoustic performance and the renovation work must include replacement of the window and door frames and installation according to the three-stage method (see "Window Acoustics" page 136).



FLOORS ASSEMBLIES

ACOUSTIC UPGRADES FROM ABOVE

Cover the underside of the floor by applying a resilient layer **PIANO A**, **SILENT UNDERFLOOR**, **GEMINI**, **GIPS BAND**, **CONSTRUCTION SEALING** to the joists and by adding mass to the plasterboard sheet with **SILENT WALL BYTUM** or **SILENT WALL BYTUM SA**

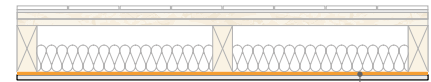
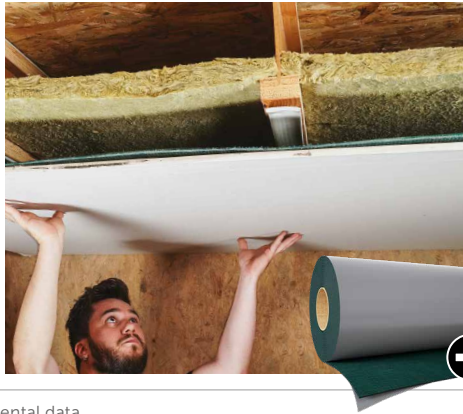

SILENT WALL BYTUM SA

$$\Delta R_w = +15 \text{ dB}$$

$$\Delta STC_{ASTM} = +8$$

$$\Delta L_{n,w} = -17 \text{ dB}$$

$$\Delta IIC_{ASTM} = +17$$

The addition of the resilient layer **PIANO A** or **SILENT FLOOR EVO** in strips produces a further improvement (approx. 4dB)

Values obtained through calculations from experimental data.

POSSIBILITY OF INTERVENTION ONLY FROM ABOVE

Add a resilient layer with **SILENT FLOOR PUR**, **SILENT FLOOR TEX**, **SILENT FLOOR BYTUM**, **SILENT FLOOR PE** and a an acoustic topping or double solid layer (44 + 34,6 kg/m²)

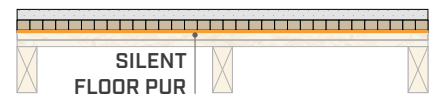

$$\Delta R_w = +12 \text{ dB}$$

$$\Delta STC_{ASTM} = +10$$

$$\Delta L_{n,w} = -22 \text{ dB}$$

$$\Delta IIC_{ASTM} = +22$$

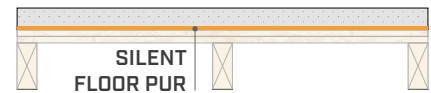

$$\Delta L_{n,w} = -21 \text{ dB}$$

$$\Delta IIC_{ASTM} = +21$$

Make a raised floor system with battens and resilient layer **PIANO A**, **SILENT FLOOR PUR** in strips, **SILENT TEX** in strips, **SILENT UNDERFLOOR**, **NAIL PLASTER**, **GEMINI**, **GIPS BAND**, **CONSTRUCTION SEALING** and a double solid layer (44 + 34.6 kg/m²)

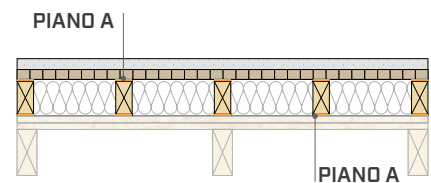

$$\Delta R_w = +12 \text{ dB}$$

$$\Delta STC_{ASTM} = +13$$

$$\Delta L_{n,w} = -31 \text{ dB}$$

$$\Delta IIC_{ASTM} = +31$$

Values obtained from laboratory tests on CLT floor.

FULL RETROFIT

Acoustic upgrades from both sides of a floor or wall assembly achieves higher performance, but requires greater thickness and the access for installation

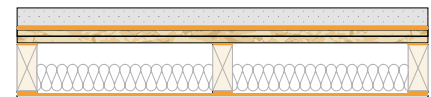

DID YOU KNOW THAT...

When building a new floor assembly, it is a good idea to provide a resilient **SILENT STEP** or **SILENT STEP ALU** layer underneath the floating floor for maximum acoustic performance.



INSTALLATIONS

Solutions vary depending on the type of construction and acoustic requirements.

Create a mechanical, electrical, plumbing (MEP) enclosure and use **SILENT WALL BYTUM** or **SILENT WALL BYTUM SA** to improve its sound reduction index

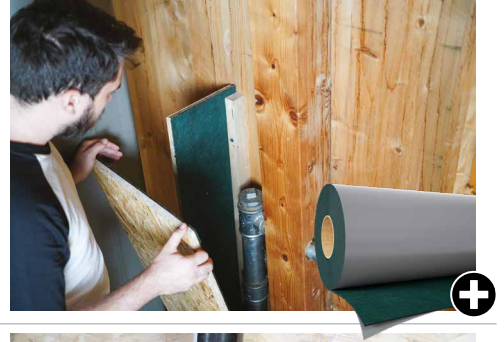

Seal any gaps created by the MEP penetrations with **HERMETIC FOAM** or **FIRE SEALING SILICONE**



Place a resilient layer **PIANO A**, **SILENT FLOOR PUR** in strips, **SILENT FLOOR TEX** in strips, **SILENT UNDERFLOOR**, **GIPS BAND**, **CONSTRUCTION SEALING** between the MEP components and the fixing system to avoid rigid contact with other elements.



ACOUSTIC DESIGN OF BUILDINGS

For the project to be successful and achieve high levels of comfort, it is necessary to adopt a multi-disciplinary approach and to involve the acoustic designer at an early stage in order to make design choices that take into account solutions aimed at noise reduction. Good acoustic design in fact starts with the correct design of the structure, where action can be taken to minimise flanking sound transmission.

Rothoblaas recommends a competent technician who will take the various aspects of acoustic design into account:

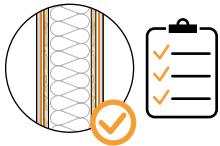

DIRECT SOUND TRANSMISSION AND CHOICE OF MATERIALS

If project requirements allow it, it is preferable to choose a construction assembly that has already been tested in the laboratory. It must be taken into account that, in general, elastic materials, added mass and raised floors help to improve performance.

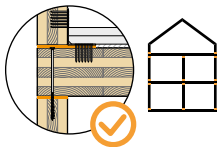

REDUCTION OF FLANKING SOUND TRANSMISSION

Structural elements must be separated with appropriately calculated resilient profiles to prevent the propagation of vibrations and thus noise through the structure.

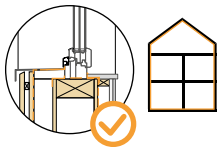

ATTENTION TO DETAILS

Ensure airtight construction to limit airborne sound transmission through cracks. Air is one of the main mediums through which sound waves travel.

REDUCTION OF FLANKING SOUND TRANSMISSION

In buildings, sound transmission between rooms is characterised not only by direct transmission but also by sound propagation through the structure. The effect of sound spreading through the connections and intersections in the structure is called flanking sound transmission and can drastically reduce the acoustic performance of walls and floors. To minimise this phenomenon, it is necessary to decouple the structural elements. XYLOFON, PIANO and ALADIN placed between rigid elements prevent the propagation of vibrations in the structure and reduce sound transmission in the between adjacent areas in the structure.

The contribution of resilient profiles can be assessed in terms of K_{ij}

with **XYLOFON**: $\Delta_{l,ij} > 6 \text{ dB}$

K_{ij} measured for different configurations and with different hardnesses of XYLOFON

The reduction in lateral transmission can also be assessed in terms of $R_{ij,situ}$ and $L_{n,ij,situ}$

with **XYLOFON**: $\Delta R_{ij,situ} = 10 \text{ dB}$
 $\Delta L_{n,ij,situ} = 8 \text{ dB}$



DIRECT SOUND TRANSMISSION AND CHOICE OF MATERIALS

Rothoblaas provides a database full of solutions measured in the laboratory and on site that are useful for defining the project construction assembly.

Here are some examples: see the manual to learn about all the solutions tested by Rothoblaas.

FLOOR SLAB

CLT with double screed with false ceiling

Various solutions were tested in the laboratory and on site with **XYLOFON** and **ALADIN** and various products from the **SILENT FLOOR** and **SILENT STEP** ranges

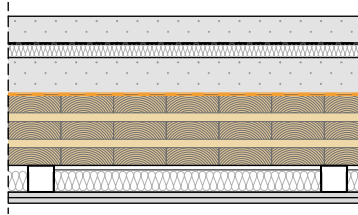

R_w = from **59** dB to **62** dB
 STC_{ASTM} = from **57** to **64**

$R_{w,1}$ = from **50** dB to **34** dB
 IIC_{ASTM} = from **62** to **75**

CLT with double screed without false ceiling

Various solutions were tested in the laboratory and on site with **XYLOFON** and different products from the **SILENT FLOOR** range

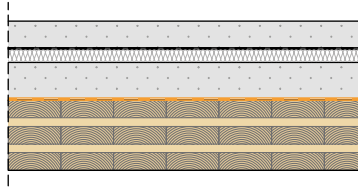

R_w = from **53** dB to **57** dB
 STC_{ASTM} = from **53** to **57**

$L_{n,w}$ = from **60** dB to **48** dB
 IIC_{ASTM} = from **50** to **62**

CLT and raised floor

Different types of raised floor were tested in the laboratory and on site with **XYLOFON** using **PIANO A** and **GRANULO**

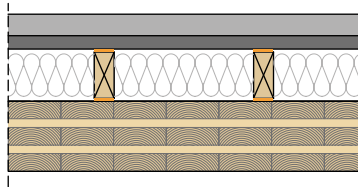

$L_{n,w}$ = from **57** dB to **47** dB
 IIC_{ASTM} = from **43** to **50**

CLT with single screed without false ceiling

Different configurations were tested in the laboratory and on site with **XYLOFON** using products from the **SILENT FLOOR** range in single and double layers

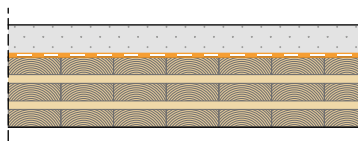

$L_{n,w}$ = from **67** dB to **61** dB
 IIC_{ASTM} = from **53** to **63**

WALL

CLT

Different wall types with one or two supporting walls and the use of **SILENT WALL** and **SILENT UNDERFLOOR** were tested in the laboratory

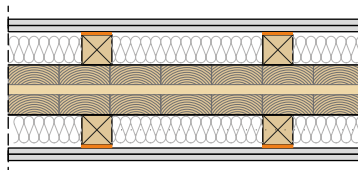

R_w = from **46** dB to **59** dB
 STC_{ASTM} = from **46** to **59**

CLT façade

The façade was tested in the laboratory with **GIPS BAND**

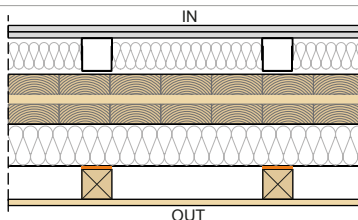

R_w = **58** dB
 STC_{ASTM} = **56**

Frame without supporting wall

Various wall types were tested in the laboratory using products from the **SILENT WALL** and **SILENT FLOOR PUR** range

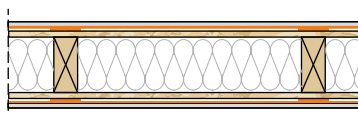

R_w = from **48** dB to **55** dB
 STC_{ASTM} = from **49** to **55**

Frame with supporting wall

Various wall types were tested in the laboratory using products from the **SILENT WALL**, **GIPS BAND** and **SILENT FLOOR PUR** ranges

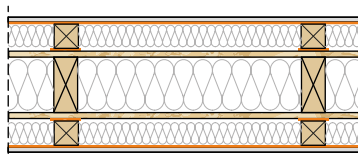

R_w = from **50** dB to **70** dB
 STC_{ASTM} = from **49** to **65**

STRUCTURAL NOISE

STRUCTURAL NOISE

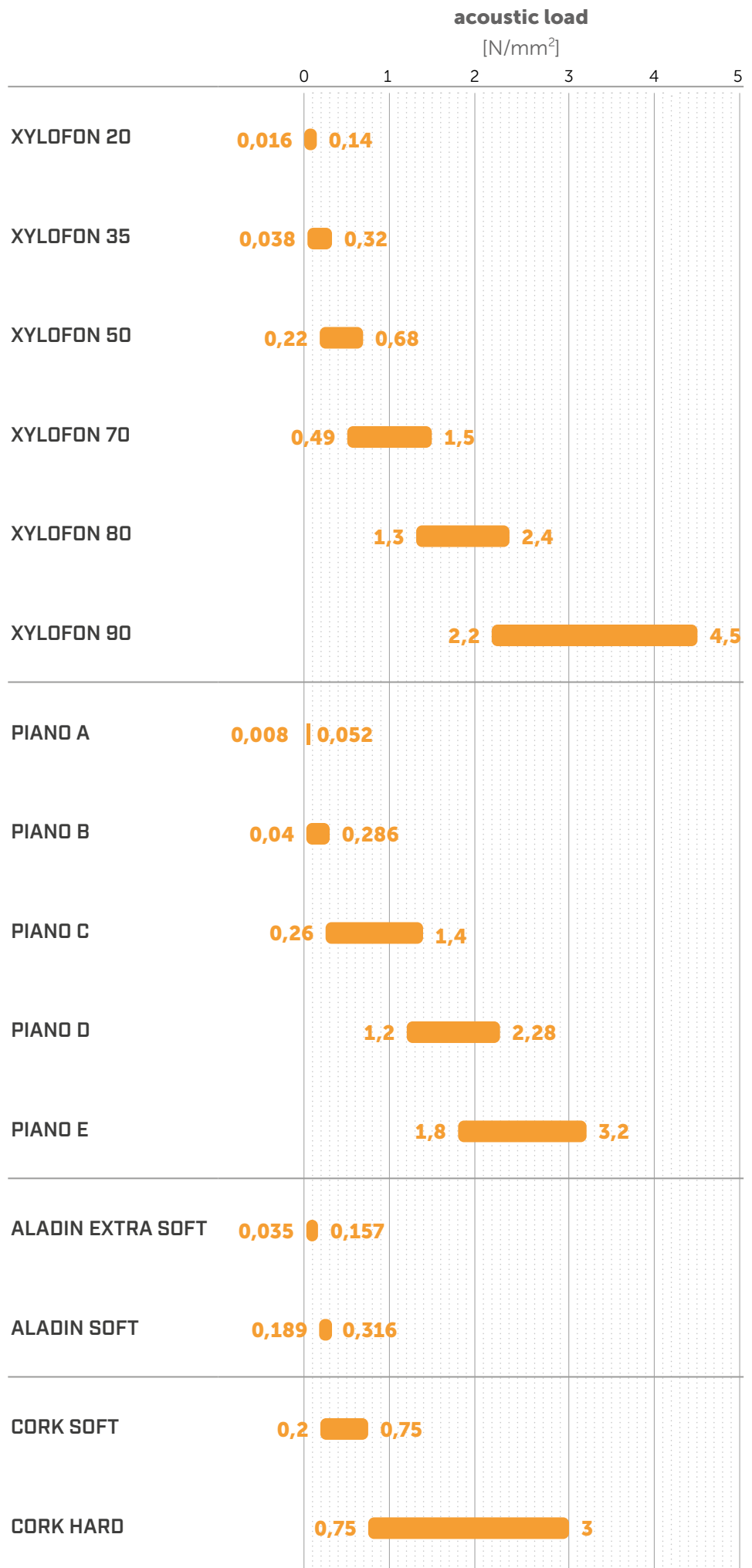

STRUCTURAL NOISE

XYLOFON <i>HIGH PERFORMANCE RESILIENT SOUNDPROOFING PROFILE</i>	88
XYLOFON WASHER <i>SEPARATING WASHER FOR TIMBER SCREW AND WHT</i>	102
XYLOFON PLATE <i>SEPARATING PROFILE FOR TIMBER SHEAR BRACKET ANGLES</i>	104
PIANO <i>RESILIENT SOUNDPROOFING PROFILE</i>	106
CORK <i>ECOLOGICAL PANEL FOR ACOUSTIC INSULATION</i>	116
ALADIN <i>RESILIENT SOUNDPROOFING PROFILE</i>	118
TRACK <i>RESILIENT SOUNDPROOFING PROFILE</i>	122
GRANULO STRIPE <i>RESILIENT GRANULAR RUBBER SOUNDPROOFING PROFILE</i>	124
TIE-BEAM STRIPE <i>TIE BEAM SEALING PROFILE</i>	126

REDUCTION OF FLANKING SOUND TRANSMISSION

In the laboratory or on site, is the result identical? The answer, of course, is no, and in fact measurements of sound reduction index and impact level, with the same construction assembly, produce very different results.

LABORATORY MEASUREMENTS

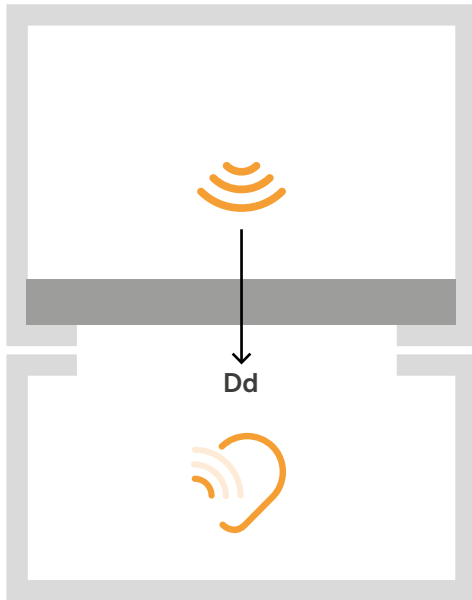

In a laboratory, the component to be tested is installed in rooms decoupled from each other that are designed specifically for that purpose. Measurements in the laboratory are characterised by direct transmission, i.e. only through the separating construction element.

ON SITE MEASUREMENTS

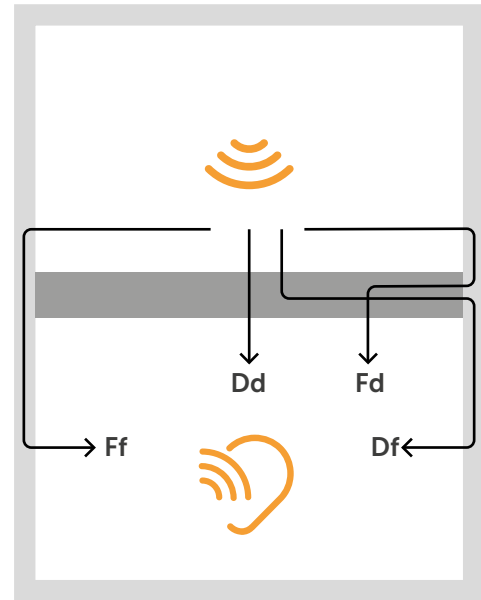

When the sound reduction index is measured on site, the value is lower than that measured in the laboratory for the same construction assembly. This is because transmission between rooms is also characterised by flanking sound transmission, i.e. the contributions to propagation made by structural or rigid building elements.

The designer must be able to correctly estimate the size and contribution of flanking sound transmission, which can be quite significant, to ensure compliance with the passive acoustic requirements measured on site.

4 SIDES BETWEEN WHICH FLANKING SOUND TRANSMISSION TAKES PLACE

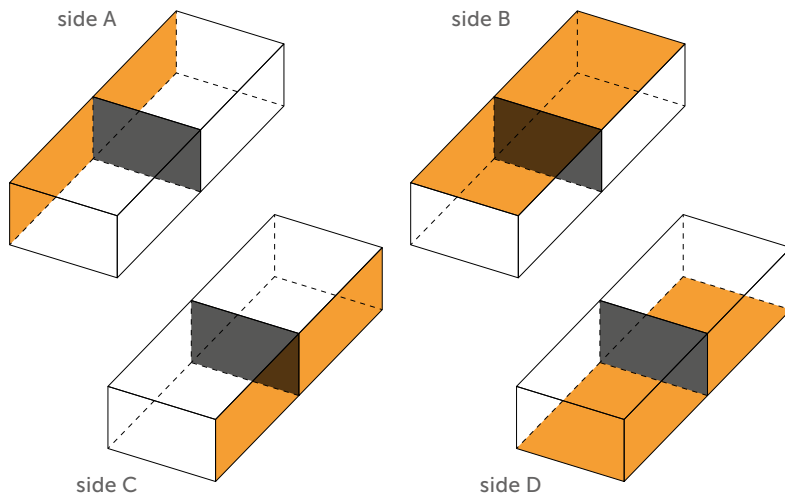

3 TRANSMISSION PATHS

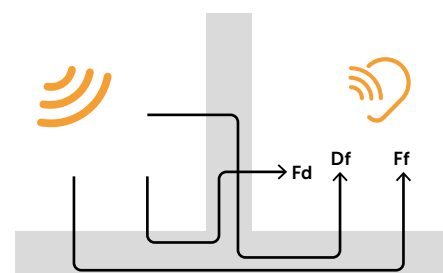

**4 sides x 3 paths =
12
transmission paths**

Timber structures, like all lightweight types of construction, do not have high acoustic performance due to transmission of vibration through the elements that make up the structure: for this reason, timber structures must be designed with a different mentality than traditional structures.

Vibration propagation must also be stopped at the structural level in order to have a reduction in noise transmission.

WHAT DOES DECOUPLING CONSIST OF?

Decoupling is the action or construction technique in which elements are kept separate or isolated, as contact between them would allow the transmission of vibrations and thus noise.

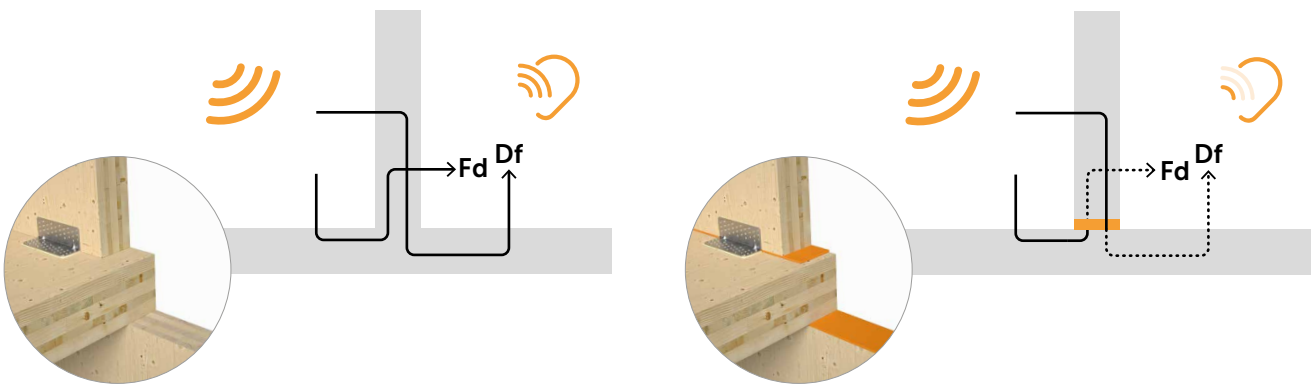

RESILIENT PRODUCTS

These are elastic separating layers between rigid elements whose main purpose is to prevent the transmission of vibrations in the building structure, for example impacts or noise from footsteps, to its structural elements.

Working at this level of the structure means being able to solve the problem at the source, allowing greater flexibility during design and modification of the other layers and materials within the assembly, such as thermal and acoustic insulation or coverings and various architectural finishes.

ESTIMATION OF FLANKING SOUND TRANSMISSION (ISO 12354)

Lateral transmission can be estimated as:

$$R_{ij,w} = \frac{R_{i,w} + R_{j,w}}{2} + \Delta R_{ij,w} + K_{ij} + 10 \log \frac{S}{I_0 I_{ij}} \text{ (dB)}$$

The parameter that takes into account structural decoupling and represents the energy dissipated by the joint is the VIBRATION REDUCTION INDEX K_{ij} .

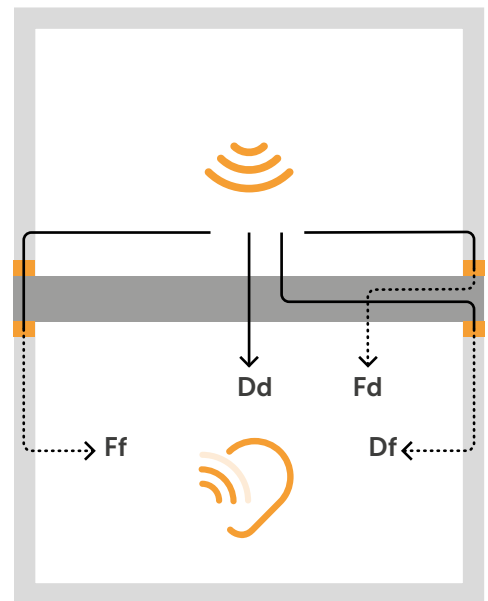

The ASTM standards currently do not provide a predictive model for the evaluation of lateral transmission, so the ISO 12354 and ISO 10848 standards are used and "translated" into the ASTM metric.

ASTM & K_{ij}

$$STC_{ij} = \frac{STC_i}{2} + \frac{STC_j}{2} + K_{ij} + \max(\Delta STC_i, \Delta STC_j) + \frac{\min(\Delta STC_i, \Delta STC_j)}{2} + 10 \log \frac{S_s}{I_0 I_{ij}}$$

CORRECT DESIGN OF RESILIENT PROFILES

CORRECT DESIGN OF STRUCTURAL JOINTS

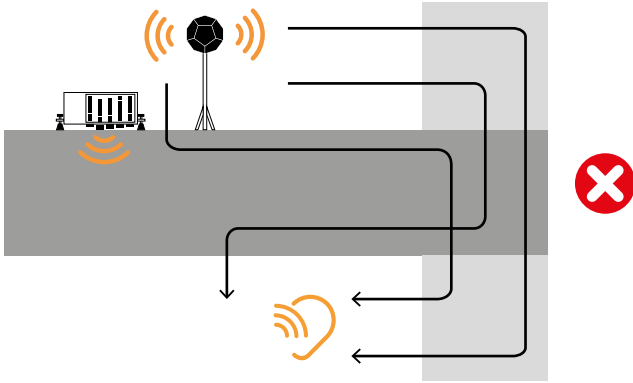

If resilient profiles are not included in the design, the propagation of vibrations at the structural level is not interrupted and the contribution of flanking sound transmission can be significant, both for airborne sound and the impact sound.

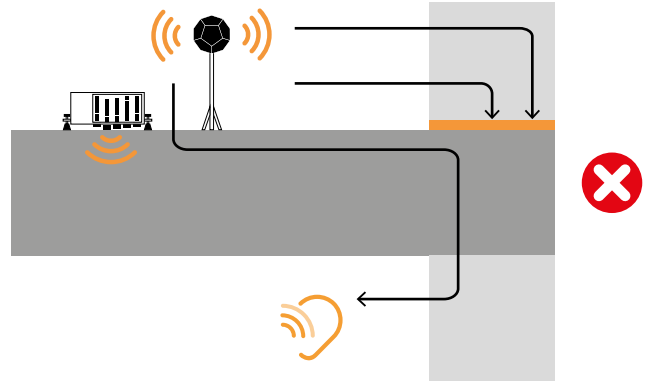

The profile, placed only above the floor, interrupts part of the propagation of vibrations generated by airborne noise. The absence of the lower profile causes part of the airborne noise and all impact noise to propagate indirectly.

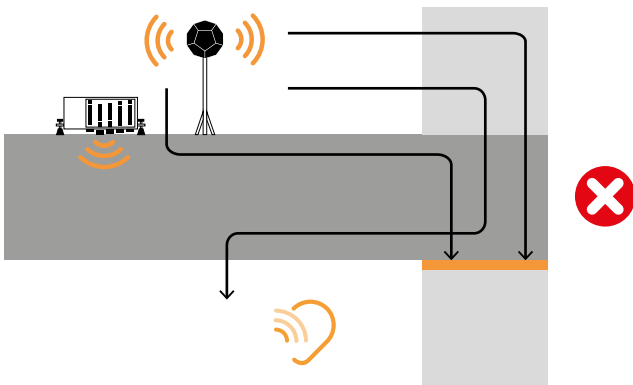

The profile placed only below the ceiling interrupts the propagation of vibrations generated by impact noise. As we can see, this configuration lacks the profile that interrupts the propagation of vibrations generated by airborne noise.

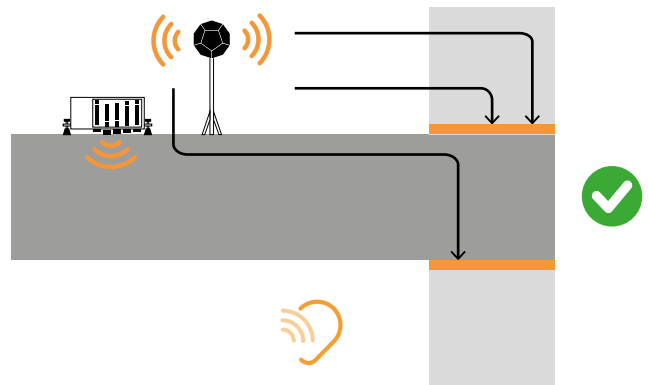

Due to the presence of the resilient profile both above and below the floor, all lateral transmission paths were interrupted and the propagation of vibrations through the structure was minimised.

DESIGNING THE CORRECT PROFILE ACCORDING TO THE LOAD

Resilient profiles must be correctly loaded in order to isolate the low to medium frequencies of structurally transmitted vibrations: guidance on how to proceed with the evaluation of the product are given below.

It is advisable to add the permanent load value at 50% of the characteristic value of the accidental load.

$$Q_{\text{linear}} = q_{\text{gk}} + 0,5 q_{\text{vk}}$$

$$Q_{\text{linear}} = \text{DL} + 0,5 \text{LL}$$

It is necessary to focus on the operating conditions and not the ultimate limit state conditions. This is because the goal is to insulate the building from noise during normal operating conditions and not during design level events.

PRODUCT SELECTION



To properly evaluate the product using MyProject, simply follow the step-by-step instructions provided by the software.



The product can also be selected using the application tables (see below for the XYLOFON 35 table), which help to choose the correct product.

TABLE OF USE⁽¹⁾

CODE	load for acoustic optimisation ⁽²⁾ [kN/m]		compression for acoustic optimisation ⁽²⁾ [N/mm ²]		reduction [mm]		compressive stress at 3 mm (ultimate limit state) [N/mm ²]
	min	max	min	max	min	max	
XYL35080	3,04	25,6					
XYL35090	3,42	28,8					
XYL35100	3,8	32	0,038	0,32	0,05	0,5	3,61
XYL35120	4,56	38,4					
XYL35140	5,32	44,8					
XYL35160	6,08	51,2					

Note: The static behaviour of the material in compression is evaluated, considering that the deformations due to the loads are static. This is because a building does not present significant movement phenomena, nor dynamic deformation.

Rothoblaas has chosen to define a load range that allows good acoustic performance and avoids excessive deformation and differential movements in the materials, including the building's final architectural finishes. However, it is possible to use profiles with loads outside the indicated range if the resonance frequency of the system and the deformation of the profile at the ultimate limit state are assessed.

DETERMINATION OF PERFORMANCE

Once the loads have been identified, it is necessary to figure out what the design frequency is, namely the exciting frequency of the element of which the structure and transmissibility of the product has to be insulated, depending on the design frequency under the chosen load conditions.

The MyProject software automatically calculates natural frequency, transmissibility and attenuation, and by downloading the full manual from www.rothoblaas.com, it is possible to see all the graphs relating to product performance.

NOTE: The transmissibility graphs do not consider the influence of the fastening systems that may affect the final performance of the resilient profile: the greater the thickness of the acoustic profile, the lower the stiffness of the building. Consequently, it is necessary to increase the number of connectors to compensate for the loss of rigidity/strength. This leads to an increase in vibration "transmission points", which reduces the benefit of resilient profiles.

For this reason, it is advised to choose a laboratory-tested product, whose K_{ij} values measured with appropriate fastening systems and whose measuring conditions are declared.



Rothoblaas has invested in the development of solutions that follow a multidisciplinary approach and take into account the real conditions of the construction site. Laboratory measurements, static tests, durability tests, moisture control and fire performance studies allow the designer to benefit from real performance data and not just theoretical values that have limited practical applications.



XYLOFON

HIGH PERFORMANCE RESILIENT SOUNDPROOFING PROFILE



CERTIFIED, TESTED, DURABLE

XYLOFON is the resilient profile that provides acoustic comfort in timber structures and residential houses, but is also suitable for other building systems. Made of a polyurethane compound, it is available in 6 versions from 20 to 90 Shore, on the basis of the load it has to support.

The product is tested and certified for use as a decoupling and mechanical isolation layer between building materials. Due to its elasticity and damping capacity, the product has been tested according to international standards ISO 10848 and ISO 16283 and significantly reduces airborne and structure-borne noise transmission (from 5 to over 15 dB).

The low thickness of the six versions can support a wide range of loads without affecting the design choices. Also suitable for LVL, steel and concrete.

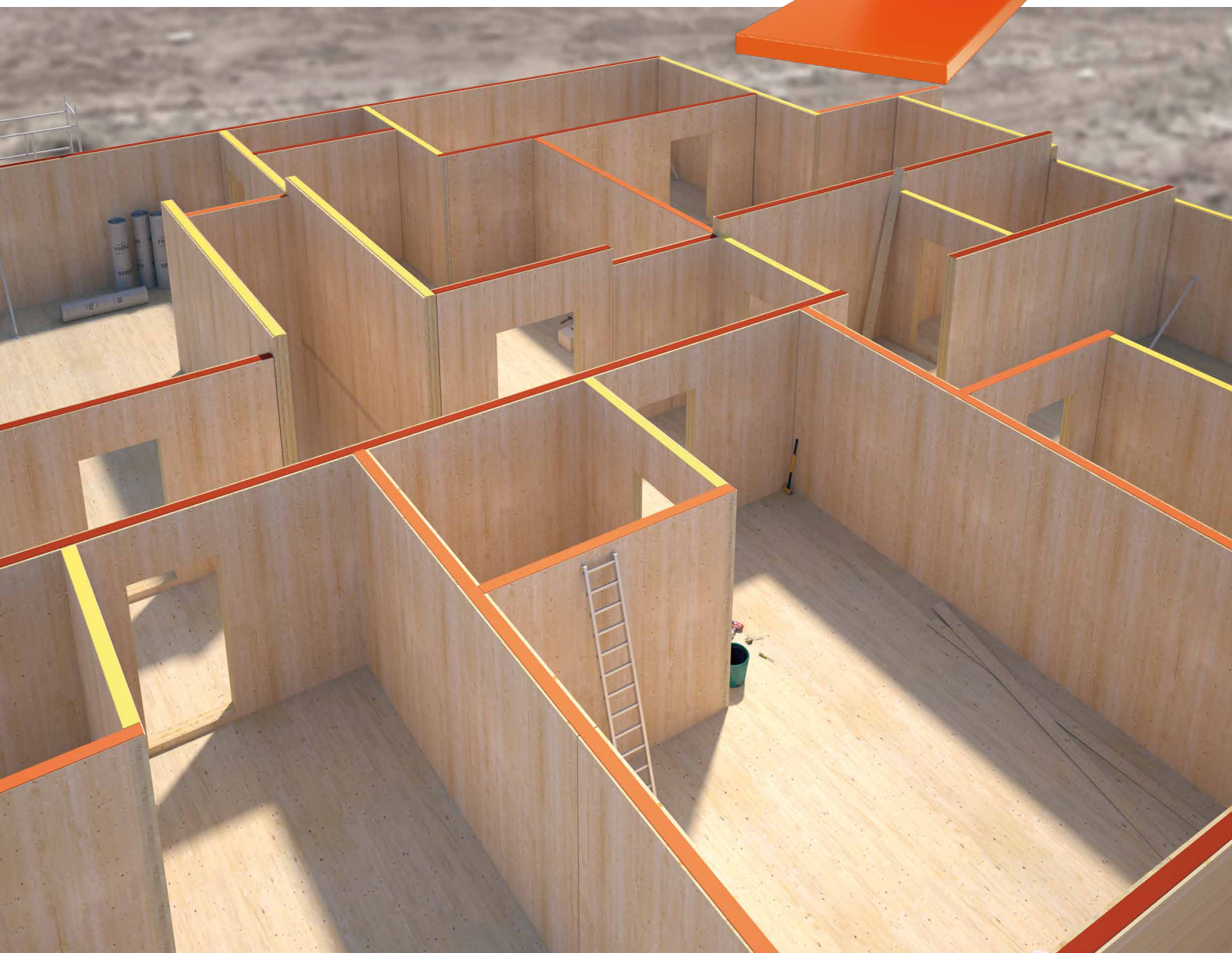

MONOLITHIC AND WATERPROOF

The monolithic structure of polyurethane guarantees impermeability, stability, long-term elastic properties and no structural failure in the long-term. XYLOFON is free of VOCs or harmful substances and is extremely chemically stable.

SMART

The profiles are easily processed and installed with the most common construction tools. Moreover, the wide range makes it ideal for every size and load of building element.

FIRE

Tested performance for characterisation and fire behaviour, both in exposed structural joints and for use in multi-storey buildings.

INTEGRATED DESIGN



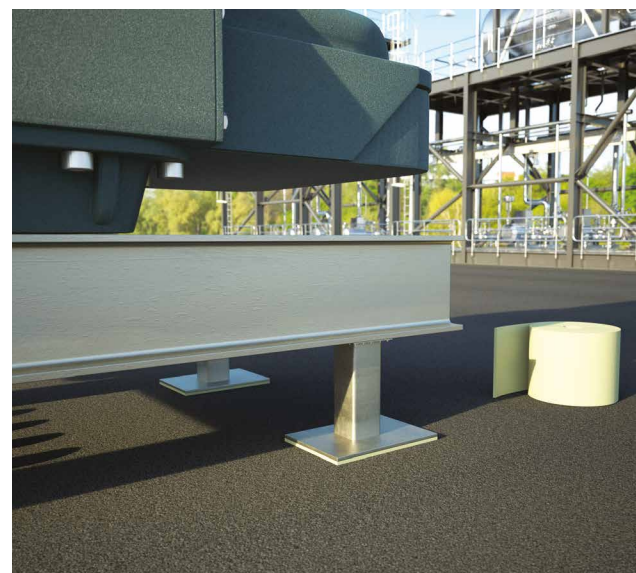
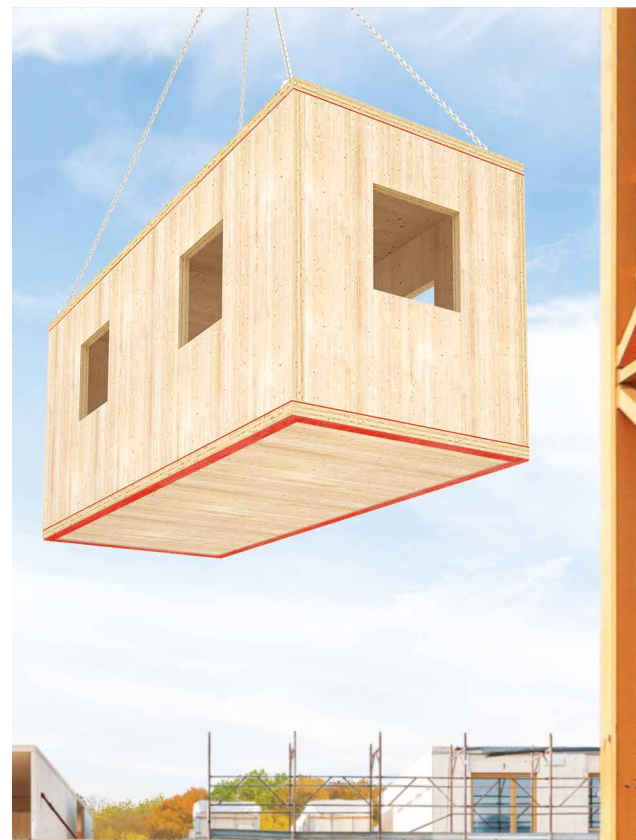

Rothoblaas has studied and tested the product over the years in the most relevant project areas: acoustics, structural capacity, moisture and fire. This allows a single solution for different needs.

CODES AND DIMENSIONS



CODE	Shore	B	L	s	B	L	s	pcs
		[mm]	[m]	[mm]	[in]	[ft]	[in]	
XYL20050	20	50	3,66	6,0	2	12	1/4	1
XYL20080		80	3,66	6,0	3 1/8	12	1/4	1
XYL20090		90	3,66	6,0	3 1/2	12	1/4	1
XYL20100		100	3,66	6,0	4	12	1/4	1
XYL20120		120	3,66	6,0	4 3/4	12	1/4	1
XYL20140		140	3,66	6,0	5 1/2	12	1/4	1
XYL20160	160	3,66	6,0	6 1/4	12	1/4	1	
XYL35080	35	80	3,66	6,0	3 1/8	12	1/4	1
XYL35090		90	3,66	6,0	3 1/2	12	1/4	1
XYL35100		100	3,66	6,0	4	12	1/4	1
XYL35120		120	3,66	6,0	4 3/4	12	1/4	1
XYL35140		140	3,66	6,0	5 1/2	12	1/4	1
XYL35160		160	3,66	6,0	6 1/4	12	1/4	1
XYL50080	50	80	3,66	6,0	3 1/8	12	1/4	1
XYL50090		90	3,66	6,0	3 1/2	12	1/4	1
XYL50100		100	3,66	6,0	4	12	1/4	1
XYL50120		120	3,66	6,0	4 3/4	12	1/4	1
XYL50140		140	3,66	6,0	5 1/2	12	1/4	1
XYL50160		160	3,66	6,0	6 1/4	12	1/4	1
XYL70080	70	80	3,66	6,0	3 1/8	12	1/4	1
XYL70090		90	3,66	6,0	3 1/2	12	1/4	1
XYL70100		100	3,66	6,0	4	12	1/4	1
XYL70120		120	3,66	6,0	4 3/4	12	1/4	1
XYL70140		140	3,66	6,0	5 1/2	12	1/4	1
XYL70160		160	3,66	6,0	6 1/4	12	1/4	1
XYL80080	80	80	3,66	6,0	3 1/8	12	1/4	1
XYL80090		90	3,66	6,0	3 1/2	12	1/4	1
XYL80100		100	3,66	6,0	4	12	1/4	1
XYL80120		120	3,66	6,0	4 3/4	12	1/4	1
XYL80140		140	3,66	6,0	5 1/2	12	1/4	1
XYL80160		160	3,66	6,0	6 1/4	12	1/4	1
XYL90080	90	80	3,66	6,0	3 1/8	12	1/4	1
XYL90090		90	3,66	6,0	3 1/2	12	1/4	1
XYL90100		100	3,66	6,0	4	12	1/4	1
XYL90120		120	3,66	6,0	4 3/4	12	1/4	1
XYL90140		140	3,66	6,0	5 1/2	12	1/4	1
XYL90160		160	3,66	6,0	6 1/4	12	1/4	1



PRODUCT COMPARISON

products	thickness	acoustic improvement $\Delta_{t,ij}^{(1)}$	compressive modulus E_c
 XYLOFON 20	6 mm <i>1/4 in</i>	> 7 dB	1,45 N/mm² <i>210 psi</i>
 XYLOFON 35	6 mm <i>1/4 in</i>	7,4 dB	3,22 N/mm² <i>467 psi</i>
 XYLOFON 50	6 mm <i>1/4 in</i>	10,6 dB	7,11 N/mm² <i>1031 psi</i>
 XYLOFON 70	6 mm <i>1/4 in</i>	7,8 dB	14,18 N/mm² <i>2057 psi</i>
 XYLOFON 80	6 mm <i>1/4 in</i>	> 7 dB	25,39 N/mm² <i>3683 psi</i>
 XYLOFON 90	6 mm <i>1/4 in</i>	> 7 dB	36,56 N/mm² <i>5303 psi</i>

LEGEND:

-  load for acoustic optimisation
-  compressive stress at 3 mm (ultimate limit state)

dynamic elastic modulus $E'_{5\text{Hz}} - E'_{50\text{Hz}}$	damping factor $\tan\delta_{5\text{Hz}} - \tan\delta_{50\text{Hz}}$	acoustic load / maximum applicable load	
		0	5
-	-	acoustic load [N/mm ²] 0,016 0,14	maximum applicable load [N/mm ²] 0,016 1,25
3,10 N/mm² - 3,60 N/mm² <i>1305 psi - 1552 psi</i>	0,321 - 0,382	acoustic load [N/mm ²] 0,038 0,32	maximum applicable load [N/mm ²] 0,038 3,61
3,93 N/mm² - 4,36 N/mm² <i>1610 psi - 1958 psi</i>	0,173 - 0,225	acoustic load [N/mm ²] 0,22 0,68	maximum applicable load [N/mm ²] 0,22 8,59
6,44 N/mm² - 7,87 N/mm² <i>2393 psi - 3104 psi</i>	0,118 - 0,282	acoustic load [N/mm ²] 0,49 1,5	maximum applicable load [N/mm ²] 0,49 11,1
16,90 N/mm² - 21,81 N/mm² <i>3568 psi - 4487 psi</i>	0,150 - 0,185	acoustic load [N/mm ²] 1,3 2,4	maximum applicable load [N/mm ²] 1,3 19,51
39,89 N/mm² - 65,72 N/mm² <i>6150 psi - 8093 psi</i>	0,307 - 0,453	acoustic load [N/mm ²] 2,2 4,5	maximum applicable load [N/mm ²] 2,2 28,97

⁽¹⁾ $\Delta_{l,ij} = K_{ij,with} - K_{ij,without}$. See the manual for more information on configuration.

XYLOFON 20

CODES AND DIMENSIONS

CODE	Shore	B	L	s	B	L	s	pcs
		[mm]	[m]	[mm]	[in]	[ft]	[in]	
XYL20050	20	50	3,66	6,0	2	12	1/4	1
XYL20080		80	3,66	6,0	3 1/8	12	1/4	1
XYL20090		90	3,66	6,0	3 1/2	12	1/4	1
XYL20100		100	3,66	6,0	4	12	1/4	1
XYL20120		120	3,66	6,0	4 3/4	12	1/4	1
XYL20140		140	3,66	6,0	5 1/2	12	1/4	1
XYL20160		160	3,66	6,0	6 1/4	12	1/4	1

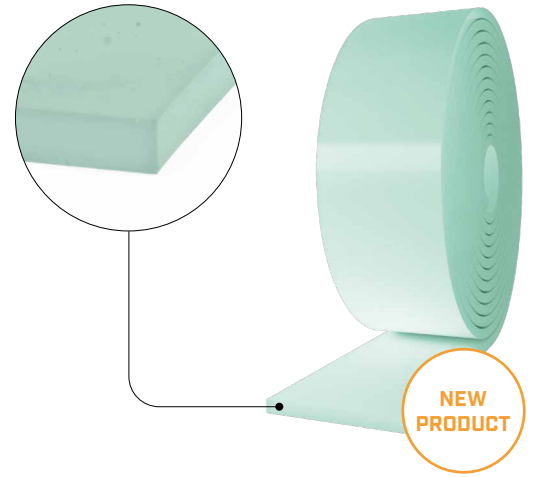

TABLE OF USE⁽¹⁾

CODE	load for acoustic optimisation ⁽²⁾ [kN/m] [lbf/ft]		compression for acoustic optimisation ⁽²⁾ [N/mm ²] [psi]		reduction [mm] [mil]		compressive stress at 3 mm (ultimate limit state) [N/mm ²] [psi]
	min	max	min	max	min	max	
XYL20050	0,7	590	8	5163	0,016 2.32	0,14 20.3	1,25 181
XYL20080	1,12	944	12,8	8261			
XYL20090	1,26	1062	14,4	9293			
XYL20100	1,4	1180	16	10326			
XYL20120	1,68	1416	19,2	12391			
XYL20140	1,96	1652	22,4	14456			
XYL20160	2,24	1888	25,6	16521			

⁽¹⁾The load ranges reported are optimised with respect to the static behaviour of the material assessed under compression, considering the effect of friction and the system resonance frequency, which falls between 20 and 30 Hz, with a maximum deformation of 12%. See the manual or use MyProject to view transmissibility and attenuation graphs.

⁽²⁾Resilient profiles must be properly loaded in order to isolate medium/low frequency vibrations transmitted structurally. It is advisable to assess the load according to the operating conditions because the building must be acoustically insulated under everyday load conditions (add the value of the permanent load to 50% of the characteristic value of the incidental load $Q_{linear} = q_{gk} + 0.5 q_{vk}$).

TECHNICAL DATA: available upon request.

LIGHTNESS AND HEIGHT

XYLOFON 20 is the range innovation for light structures and low loads. The acoustic insulation performance is the same as for Mass Timber structures, but the 20 shore polyurethane compound allows for use on light-frame structures, roofs and floors.

In the construction of multi-storey buildings, the use of XYLOFON 20 ensures soundproofing of the highest floors.



PERFORMANCE

Acoustic improvement tested:

$$\Delta_{l,ij}^{(3)} : > 7 \text{ dB}$$

Maximum applicable load
(deformation 3 mm):

$$1,25 \text{ N/mm}^2$$

Acoustic load:

$$\text{from } 0,016 \text{ to } 0,14 \text{ N/mm}^2$$

XYLOFON 35

CODES AND DIMENSIONS

CODE	Shore	B	L	s	B	L	s	pcs
		[mm]	[m]	[mm]	[in]	[ft]	[in]	
XYL35080	35	80	3,66	6,0	3 1/8	12	1/4	1
XYL35090		90	3,66	6,0	3 1/2	12	1/4	1
XYL35100		100	3,66	6,0	4	12	1/4	1
XYL35120		120	3,66	6,0	4 3/4	12	1/4	1
XYL35140		140	3,66	6,0	5 1/2	12	1/4	1
XYL35160		160	3,66	6,0	6 1/4	12	1/4	1

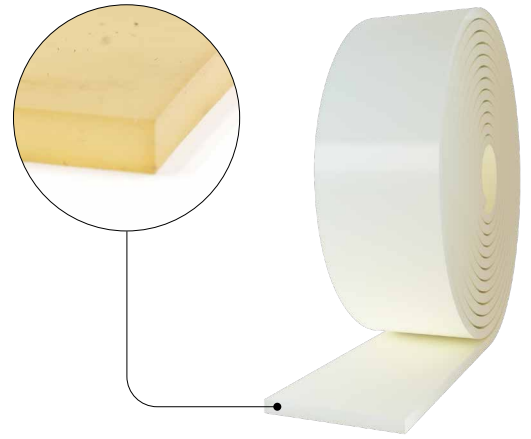

TABLE OF USE⁽¹⁾

CODE	load for acoustic optimisation ⁽²⁾ [kN/m] [lbf/ft]		compression for acoustic optimisation ⁽²⁾ [N/mm ²] [psi]		reduction [mm] [mil]		compressive stress at 3 mm (ultimate limit state) [N/mm ²] [psi]
	min	max	min	max	min	max	
XYL35080	3,04	2242	25,6	18882			
XYL35090	3,42	2522	28,8	21242			
XYL35100	3,8	2803	32	23602	0,038	0,32	3,61
XYL35120	4,56	3363	38,4	28322	5.5	46.4	524
XYL35140	5,32	3924	44,8	33043			
XYL35160	6,08	4484	51,2	37763			

⁽¹⁾The load ranges reported here are optimised with respect to the acoustic and static behaviour of the material in compression. However, it is possible to use profiles with loads outside the indicated range if the resonance frequency of the system and the deformation of the profile at the ultimate limit state are assessed. See the manual for transmissibility and attenuation graphs.

⁽²⁾Resilient profiles must be properly loaded in order to isolate medium/low frequency vibrations transmitted structurally. It is advisable to assess the load according to the operating conditions because the building must be acoustically insulated under everyday load conditions (add the value of the permanent load to 50% of the characteristic value of the incidental load $Q_{linear} = q_{gk} + 0.5 q_{vk}$).

TECHNICAL DATA

Properties	standard	value	USC conversion
Acoustic improvement $\Delta_{l,ij}$ ⁽³⁾	ISO 10848	7,4 dB	-
Compressive modulus E_c	ISO 844	3,22 MPa	467 psi
Dynamic elastic modulus $E'_{5Hz} \cdot E'_{50Hz}$	ISO 4664-1	3,10 MPa - 3,60 MPa	1305 psi - 1552 psi
Damping factor $\tan\delta_{5Hz} - \tan\delta_{50Hz}$	ISO 4664-1	0,321 - 0,382	-
Compression set c.s.	ISO 1856	0,72%	-
Compressive stress at 1 mm (1/32 in) strain σ_{1mm}	ISO 844	0,5 N/mm ²	73 psi
Compressive stress at 2 mm (1/16 in) strain σ_{2mm}	ISO 844	1,54 N/mm ²	223 psi
Compressive stress at 3 mm (1/8 in) strain σ_{3mm}	ISO 844	3,61 N/mm ²	524 psi
Dynamic stiffness $s^{(4)}$	ISO 9052	1262 MN/m ³	-
Max processing temperature (TGA)	-	200 °C	392 °F
Reaction to fire	EN 13501-1	class E	-
Water absorption after 48h	ISO 62	< 1%	-

⁽³⁾ $\Delta_{l,ij} = K_{ij,with} - K_{ij,without}$. See the manual for more information on configuration.

⁽⁴⁾The standard requires for measurement with loads between 0.4 and 4 kPa and not with the product operating load.



PERFORMANCE

Acoustic improvement tested:

$\Delta_{l,ij}$ ⁽³⁾ : **7,4 dB**

Maximum applicable load
(deformation 3 mm):

3,61 N/mm²

Acoustic load:

from **0,038** to **0,32 N/mm²**

XYLOFON 50

CODES AND DIMENSIONS

CODE	Shore	B	L	s	B	L	s	pcs
		[mm]	[m]	[mm]	[in]	[ft]	[in]	
XYL50080	50	80	3,66	6,0	3 1/8	12	1/4	1
XYL50090		90	3,66	6,0	3 1/2	12	1/4	1
XYL50100		100	3,66	6,0	4	12	1/4	1
XYL50120		120	3,66	6,0	4 3/4	12	1/4	1
XYL50140		140	3,66	6,0	5 1/2	12	1/4	1
XYL50160		160	3,66	6,0	6 1/4	12	1/4	1

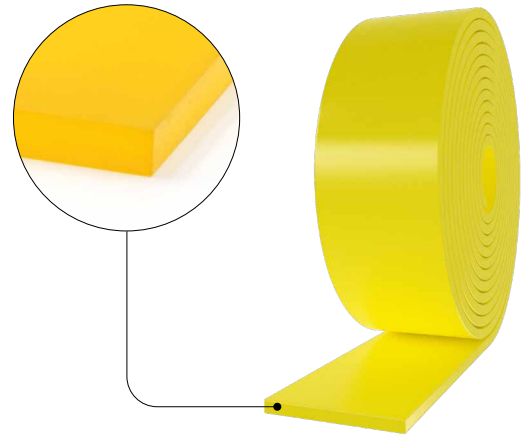

TABLE OF USE⁽¹⁾

CODE	load for acoustic optimisation ⁽²⁾ [kN/m] [lbf/ft]		compression for acoustic optimisation ⁽²⁾ [N/mm ²] [psi]		reduction [mm] [mil]		compressive stress at 3 mm (ultimate limit state) [N/mm ²] [psi]
	min	max	min	max	min	max	
XYL50080	17,6	12981	54,4	40123			
XYL50090	19,8	14604	61,2	45139			
XYL50100	22	16226	68	50154	0,22	0,68	8,59
XYL50120	26,4	19472	81,6	60185	31.9	98.6	1246
XYL50140	30,8	22717	95,2	70216			
XYL50160	35,2	25962	108,8	80247			

⁽¹⁾The load ranges reported here are optimised with respect to the acoustic and static behaviour of the material in compression. However, it is possible to use profiles with loads outside the indicated range if the resonance frequency of the system and the deformation of the profile at the ultimate limit state are assessed. See the manual for transmissibility and attenuation graphs.

⁽²⁾Resilient profiles must be properly loaded in order to isolate medium/low frequency vibrations transmitted structurally. It is advisable to assess the load according to the operating conditions because the building must be acoustically insulated under everyday load conditions (add the value of the permanent load to 50% of the characteristic value of the incidental load $Q_{linear} = q_{gk} + 0.5 q_{vk}$).

TECHNICAL DATA

Properties	standard	value	USC conversion
Acoustic improvement $\Delta_{l,ij}$ ⁽³⁾	ISO 10848	10,6 dB	-
Compressive modulus E_c	ISO 844	7,11 MPa	1031 psi
Dynamic elastic modulus $E'_{5Hz} \cdot E'_{50Hz}$	ISO 4664-1	3,93 MPa - 4,36 MPa	1610 psi - 1958 psi
Damping factor $\tan\delta_{5Hz} - \tan\delta_{50Hz}$	ISO 4664-1	0,173 - 0,225	-
Compression set c.s.	ISO 1856	1,25%	-
Compressive stress at 1 mm (1/32 in) strain σ_{1mm}	ISO 844	1,11 N/mm ²	161 psi
Compressive stress at 2 mm (1/16 in) strain σ_{2mm}	ISO 844	3,5 N/mm ²	508 psi
Compressive stress at 3 mm (1/8 in) strain σ_{3mm}	ISO 844	8,59 N/mm ²	1246 psi
Dynamic stiffness s ⁽⁴⁾	ISO 9052	1455 MN/m ³	-
Max processing temperature (TGA)	-	200 °C	392 °F
Reaction to fire	EN 13501-1	class E	-
Water absorption after 48h	ISO 62	< 1%	-

⁽³⁾ $\Delta_{l,ij} = K_{ij,with} - K_{ij,without}$. See the manual for more information on configuration.

⁽⁴⁾The standard requires for measurement with loads between 0.4 and 4 kPa and not with the product operating load.



PERFORMANCE

Acoustic improvement tested:

$\Delta_{l,ij}$ ⁽³⁾ : **10,6 dB**

Maximum applicable load
(deformation 3 mm):

8,59 N/mm²

Acoustic load:

from **0,22 to 0,68 N/mm²**

XYLOFON 70

CODES AND DIMENSIONS

CODE	Shore	B	L	s	B	L	s	pcs
		[mm]	[m]	[mm]	[in]	[ft]	[in]	
XYL70080	70	80	3,66	6,0	3 1/8	12	1/4	1
XYL70090		90	3,66	6,0	3 1/2	12	1/4	1
XYL70100		100	3,66	6,0	4	12	1/4	1
XYL70120		120	3,66	6,0	4 3/4	12	1/4	1
XYL70140		140	3,66	6,0	5 1/2	12	1/4	1
XYL70160		160	3,66	6,0	6 1/4	12	1/4	1

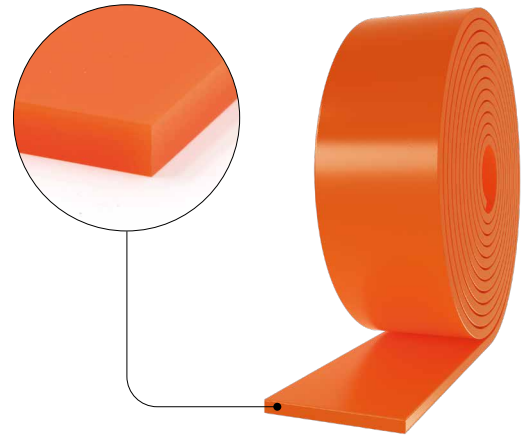

TABLE OF USE⁽¹⁾

CODE	load for acoustic optimisation ⁽²⁾ [kN/m] [lbf/ft]		compression for acoustic optimisation ⁽²⁾ [N/mm ²] [psi]		reduction [mm] [mil]		compressive stress at 3 mm (ultimate limit state) [N/mm ²] [psi]
	min	max	min	max	min	max	
XYL70080	39,2	28912	120	88507			
XYL70090	44,1	32526	135	99571			
XYL70100	49	36141	150	110634	0,49	1,5	0,2 0,65
XYL70120	58,8	43369	180	132761	71.1	218	8 26
XYL70140	68.6	50597	210	154888			11,1 1610
XYL70160	78,4	57825	240	177015			

⁽¹⁾The load ranges reported here are optimised with respect to the acoustic and static behaviour of the material in compression. However, it is possible to use profiles with loads outside the indicated range if the resonance frequency of the system and the deformation of the profile at the ultimate limit state are assessed. See the manual for transmissibility and attenuation graphs.

⁽²⁾Resilient profiles must be properly loaded in order to isolate medium/low frequency vibrations transmitted structurally. It is advisable to assess the load according to the operating conditions because the building must be acoustically insulated under everyday load conditions (add the value of the permanent load to 50% of the characteristic value of the incidental load $Q_{linear} = q_{gk} + 0.5 q_{vk}$).

TECHNICAL DATA

Properties	standard	value	USC conversion
Acoustic improvement $\Delta_{l,ij}$ ⁽³⁾	ISO 10848	7,8 dB	-
Compressive modulus E_c	ISO 844	14,18 MPa	2057 psi
Dynamic elastic modulus $E'_{5Hz} \cdot E'_{50Hz}$	ISO 4664-1	6,44 MPa - 7,87 MPa	2393 psi - 3104 psi
Damping factor $\tan\delta_{5Hz} - \tan\delta_{50Hz}$	ISO 4664-1	0,118 - 0,282	-
Compression set c.s.	ISO 1856	0,71%	-
Compressive stress at 1 mm (1/32 in) strain σ_{1mm}	ISO 844	2,44 N/mm ²	354 psi
Compressive stress at 2 mm (1/16 in) strain σ_{2mm}	ISO 844	5,43 N/mm ²	788 psi
Compressive stress at 3 mm (1/8 in) strain σ_{3mm}	ISO 844	11,1 N/mm ²	1610 psi
Dynamic stiffness $s^{(4)}$	ISO 9052	1822 MN/m ³	-
Max processing temperature (TGA)	-	200 °C	392 °F
Reaction to fire	EN 13501-1	class E	-
Water absorption after 48h	ISO 62	< 1%	-

⁽³⁾ $\Delta_{l,ij} = K_{ij,with} - K_{ij,without}$. See the manual for more information on configuration.

⁽⁴⁾The standard requires for measurement with loads between 0.4 and 4 kPa and not with the product operating load.

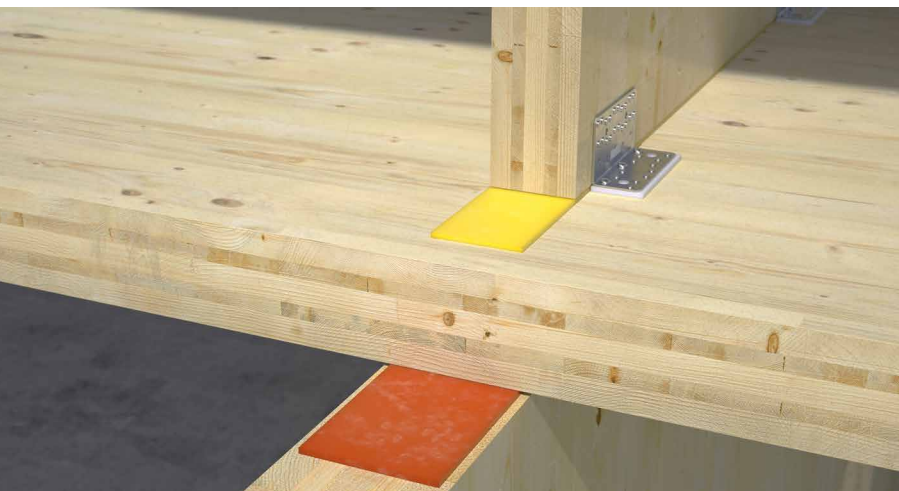

PERFORMANCE

Acoustic improvement tested

$\Delta_{l,ij}$ ⁽³⁾ : **7,8 dB**

Maximum applicable load
(deformation 3 mm):

11,1 N/mm²

Acoustic load:

from **0,49** to **1,5 N/mm²**

XYLOFON 80

CODES AND DIMENSIONS

CODE	Shore	B	L	s	B	L	s	pcs
		[mm]	[m]	[mm]	[in]	[ft]	[in]	
XYL80080	80	80	3,66	6,0	3 1/8	12	1/4	1
XYL80090		90	3,66	6,0	3 1/2	12	1/4	1
XYL80100		100	3,66	6,0	4	12	1/4	1
XYL80120		120	3,66	6,0	4 3/4	12	1/4	1
XYL80140		140	3,66	6,0	5 1/2	12	1/4	1
XYL80160		160	3,66	6,0	6 1/4	12	1/4	1

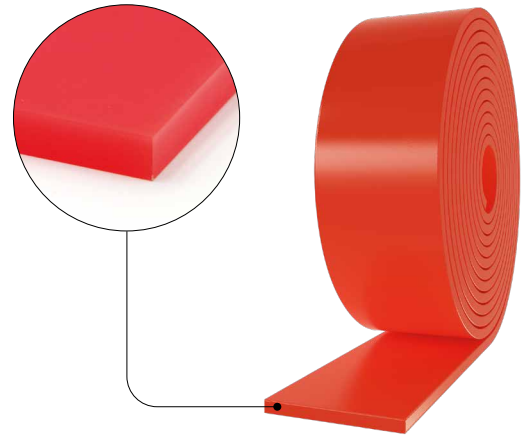

TABLE OF USE⁽¹⁾

CODE	load for acoustic optimisation ⁽²⁾ [kN/m] [lbf/ft]		compression for acoustic optimisation ⁽²⁾ [N/mm ²] [psi]		reduction [mm] [mil]		compressive stress at 3 mm (ultimate limit state) [N/mm ²] [psi]
	min	max	min	max	min	max	
XYL80080	104	76706	192	141612			
XYL80090	117	86295	216	159313			
XYL80100	130	95883	240	177015	1,3	2,4	19,51
XYL80120	156	115060	288	212418	189	348	2830
XYL80140	182	134236	336	247821			
XYL80160	208	153413	384	283224			

⁽¹⁾The load ranges reported here are optimised with respect to the acoustic and static behaviour of the material in compression. However, it is possible to use profiles with loads outside the indicated range if the resonance frequency of the system and the deformation of the profile at the ultimate limit state are assessed. See the manual for transmissibility and attenuation graphs.

⁽²⁾Resilient profiles must be properly loaded in order to isolate medium/low frequency vibrations transmitted structurally. It is advisable to assess the load according to the operating conditions because the building must be acoustically insulated under everyday load conditions (add the value of the permanent load to 50% of the characteristic value of the incidental load $Q_{linear} = q_{gk} + 0.5 q_{vk}$).

TECHNICAL DATA

Properties	standard	value	USC conversion
Acoustic improvement $\Delta_{l,ij}$ ⁽³⁾	ISO 10848	> 7 dB	-
Compressive modulus E_c	ISO 844	25,39 MPa	3683 psi
Dynamic elastic modulus $E'_{5Hz} \cdot E'_{50Hz}$	ISO 4664-1	16,90 MPa - 21,81 MPa	3568 psi - 4482 psi
Damping factor $\tan\delta_{5Hz} - \tan\delta_{50Hz}$	ISO 4664-1	0,150 - 0,185	-
Compression set c.s.	ISO 1856	1,31%	-
Compressive stress at 1 mm (1/32 in) strain σ_{1mm}	ISO 844	3,85 N/mm ²	558 psi
Compressive stress at 2 mm (1/16 in) strain σ_{2mm}	ISO 844	9,52 N/mm ²	1381 psi
Compressive stress at 3 mm (1/8 in) strain σ_{3mm}	ISO 844	19,51 N/mm ²	2830 psi
Dynamic stiffness $s^{(4)}$	ISO 9052	2157 MN/m ³	-
Max processing temperature (TGA)	-	200 °C	392 °F
Reaction to fire	EN 13501-1	class E	-
Water absorption after 48h	ISO 62	< 1%	-

⁽³⁾ $\Delta_{l,ij} = K_{ij,with} - K_{ij,without}$. See the manual for more information on configuration.

⁽⁴⁾The standard requires for measurement with loads between 0.4 and 4 kPa and not with the product operating load.



PERFORMANCE

Acoustic improvement tested:

$\Delta_{l,ij}^{(3)} : > 7$ dB

Maximum applicable load
(deformation 3 mm):

19,51 N/mm²

Acoustic load:

from **1,3** to **2,4 N/mm²**

XYLOFON 90

CODES AND DIMENSIONS

CODE	Shore	B	L	s	B	L	s	pcs
		[mm]	[m]	[mm]	[in]	[ft]	[in]	
XYL90080	90	80	3,66	6,0	3 1/8	12	1/4	1
XYL90090		90	3,66	6,0	3 1/2	12	1/4	1
XYL90100		100	3,66	6,0	4	12	1/4	1
XYL90120		120	3,66	6,0	4 3/4	12	1/4	1
XYL90140		140	3,66	6,0	5 1/2	12	1/4	1
XYL90160		160	3,66	6,0	6 1/4	12	1/4	1

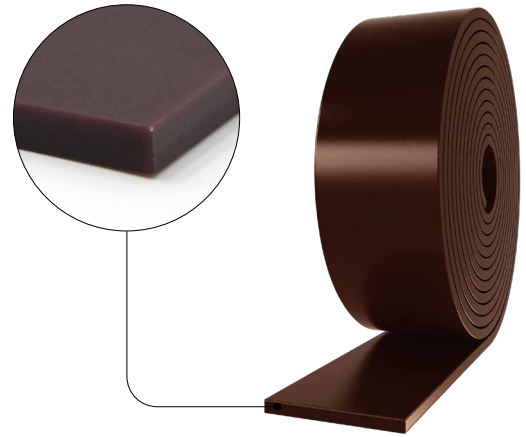

TABLE OF USE⁽¹⁾

CODE	load for acoustic optimisation ⁽²⁾ [kN/m] [lbf/ft]		compression for acoustic optimisation ⁽²⁾ [N/mm ²] [psi]		reduction [mm] [mil]		compressive stress at 3 mm (ultimate limit state) [N/mm ²] [psi]
	min	max	min	max	min	max	
XYL90080	176	129811	360	265522			
XYL90090	198	146037	405	298713			
XYL90100	220	162264	450	331903	2,2	4,5	28,97
XYL90120	264	194716	540	398283	319	653	4202
XYL90140	308	227169	630	464664			
XYL90160	352	259622	720	531045			

⁽¹⁾The load ranges reported here are optimised with respect to the acoustic and static behaviour of the material in compression. However, it is possible to use profiles with loads outside the indicated range if the resonance frequency of the system and the deformation of the profile at the ultimate limit state are assessed. See the manual for transmissibility and attenuation graphs.

⁽²⁾Resilient profiles must be properly loaded in order to isolate medium/low frequency vibrations transmitted structurally. It is advisable to assess the load according to the operating conditions because the building must be acoustically insulated under everyday load conditions (add the value of the permanent load to 50% of the characteristic value of the incidental load $Q_{linear} = q_{gk} + 0.5 q_{vk}$).

TECHNICAL DATA

Properties	standard	value	USC conversion
Acoustic improvement $\Delta_{l,ij}$ ⁽³⁾	ISO 10848	> 7 dB	-
Compressive modulus E_c	ISO 844	36,56 MPa	5303 psi
Dynamic elastic modulus $E'_{5Hz} \cdot E'_{50Hz}$	ISO 4664-1	39,89 MPa - 65,72 MPa	6150 psi - 8093 psi
Damping factor $\tan\delta_{5Hz} - \tan\delta_{50Hz}$	ISO 4664-1	0,307 - 0,453	-
Compression set c.s.	ISO 1856	2,02%	-
Compressive stress at 1 mm (1/32 in) strain σ_{1mm}	ISO 844	5,83 N/mm ²	846 psi
Compressive stress at 2 mm (1/16 in) strain σ_{2mm}	ISO 844	14,41 N/mm ²	2090 psi
Compressive stress at 3 mm (1/8 in) strain σ_{3mm}	ISO 844	28,97 N/mm ²	4202 psi
Dynamic stiffness s ⁽⁴⁾	ISO 9052	> 2200 MN/m ³	-
Max processing temperature (TGA)	-	200 °C	392 °F
Reaction to fire	EN 13501-1	class E	-
Water absorption after 48h	ISO 62	< 1%	-

⁽³⁾ $\Delta_{l,ij} = K_{ij,with} - K_{ij,without}$. See the manual for more information on configuration.

⁽⁴⁾The standard requires for measurement with loads between 0.4 and 4 kPa and not with the product operating load.

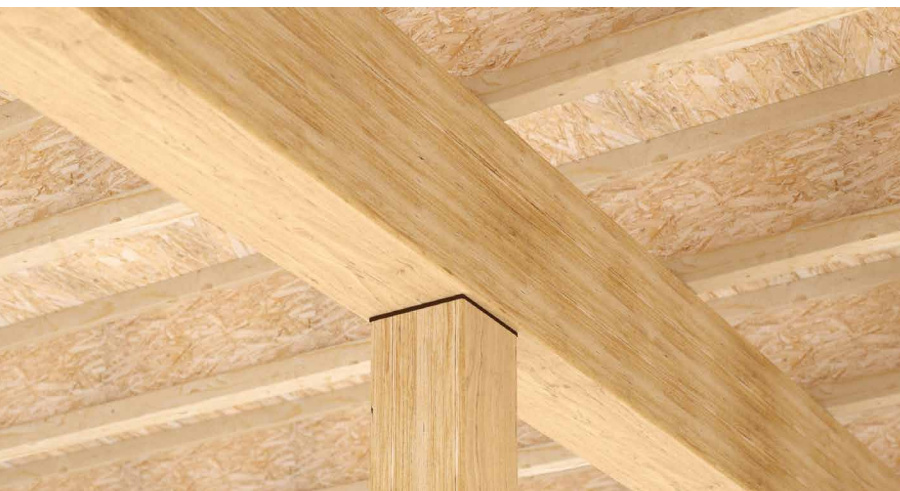

PERFORMANCE

Acoustic improvement tested:

$\Delta_{l,ij}$ ⁽³⁾ : > 7 dB

Maximum applicable load
(deformation 3 mm):

29,87 N/mm²

Acoustic load:

from **2,2 to 4,5 N/mm²**

XYLOFON | Recommendations for installation

APPLICATION WITH STAPLES

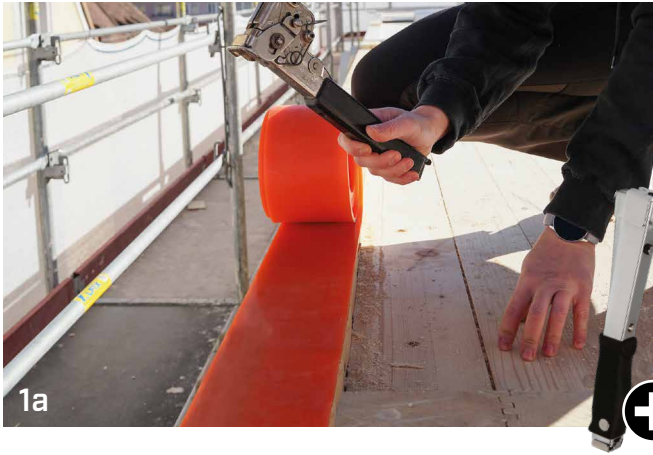

APPLICATION WITH PRIMER SPRAY



APPLICATION WITH DOUBLE BAND

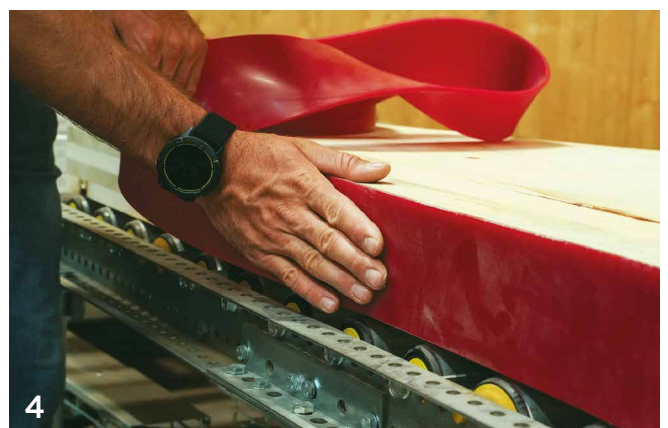
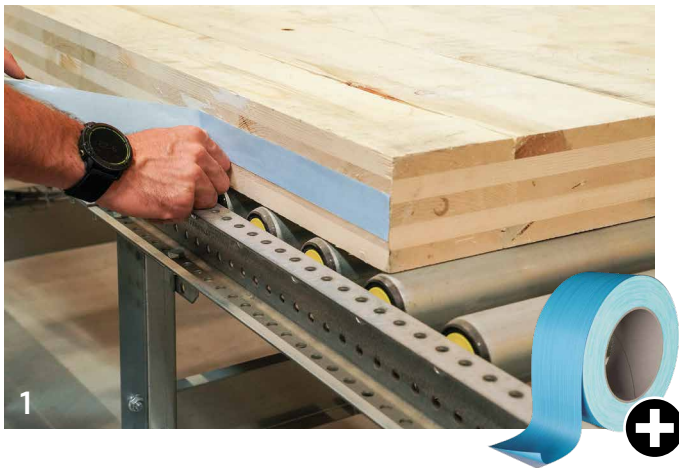

EUROPEAN TECHNICAL ASSESSMENT

The European Technical Assessment (ETA) provides an independent Europe-wide procedure for assessing the essential performance characteristics of non-standard construction products.

- Certificate of suitability for reducing flanking sound transmission and vibration within structures
- K_{ij} measured for different hardnesses and with appropriate fastening system

$$\Delta_{l,ij} > 6 \text{ dB}$$

Theoretical reduction of up to more than 15 dB when used as a vibration damper

SOUND REDUCTION INDEX MEASUREMENTS

At the University of Innsbruck, a new laboratory was set up to measure the sound reduction index of CLT buildings with the aim of determining the effectiveness of the resilient profiles to be installed between the walls and floor.

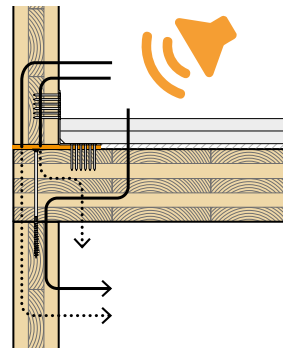
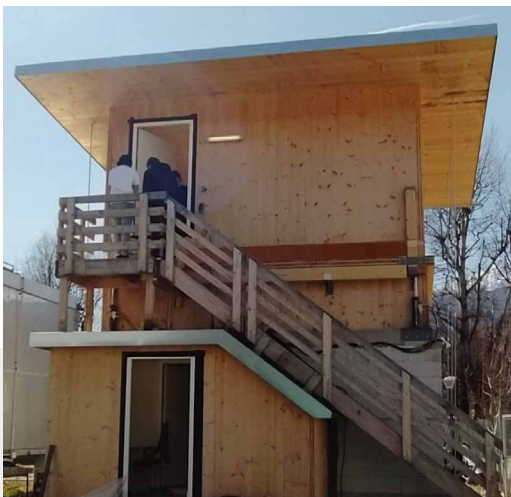

$$\Delta R_{Df+Ff,situ} = 5 \text{ dB}$$

$$\Delta STC_{Df+Ff,situ} = 4 \text{ dB}$$

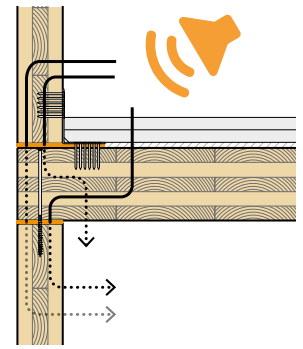

$$\Delta R_{Df+Ff,situ} = 10 \text{ dB}$$

$$\Delta STC_{Df+Ff,situ} = 10 \text{ dB}$$

IMPACT NOISE LEVEL MEASUREMENTS

In this laboratory, it is also possible to measure the impact noise level in CLT buildings and to measure the effectiveness of resilient profiles placed between the walls and the floor.

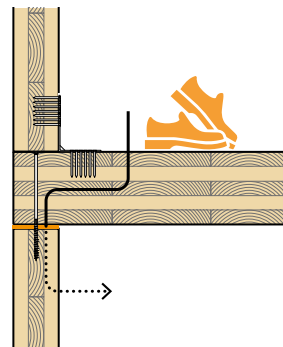

$$\Delta L_{n,Df+Ff,situ} = 7 \text{ dB}$$

$$\Delta IIC_{Df+Ff,situ} = 7 \text{ dB}$$

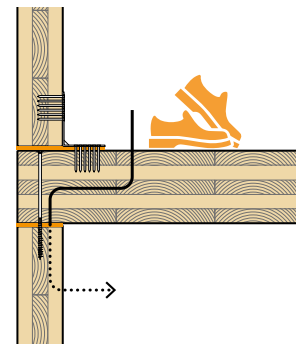

$$\Delta L_{n,Df+Ff,situ} = 8 \text{ dB}$$

$$\Delta IIC_{Df+Ff,situ} = 8 \text{ dB}$$

INTEGRATED DESIGN - FLANKSOUND PROJECT

Rothoblaas has financed research projects aimed at measuring the K_{ij} vibration reduction index for a variety of CLT panel joints, with the dual objective of providing specific experimental data for acoustic design and contributing to the development of analytical calculation methods.

- Influence of CLT type and thickness
- Influence of type and number of screws
- Influence of type and number of angle brackets and connectors
- Influence of XYLOFON



K_{ij} for **15 different** types of joint

FIRE

Awareness of fire design is increasingly growing. Over the years, Rothoblaas has carried out numerous tests to increase its know-how on this subject and will continue to do so in the future. Characterisation tests for EI behaviour were carried out at the ETH Zürich and the Institute of Structural Engineering (IBK) & Swiss Timber Solutions AG.

After 60 minutes of exposure to fire, the temperature of the unexposed surface remained about room temperature, showing no colour changes.

Rothoblaas was also a partner in the research project "Fire Safe implementation of visible mass timber in tall buildings", sponsored by RISE - Research Institutes of Sweden. This project made it possible to study the compartmentalisation of timber buildings and to analyse the limits of structures with exposed CLT.

More information on RISE Report 2021:40.



experimental test **EI 60**



STATICS AND ACOUSTICS

Rothoblaas also subsidised research campaigns aimed at characterising the mechanical behaviour of connections incorporating the resilient XYLOFON profile. This was in cooperation with the Universities of Bologna, Innsbruck and Graz.

Thanks to these studies, it was possible to optimise the thickness and material of XYLOFON to ensure a balance between static and acoustic performance.

- Influence of XYLOFON with different screw diameters
- Influence of XYLOFON in nail connections
- Testing of timber-to-timber joints
- Tests on timber-to-steel joints
- Influence of friction in shear connections

over **100 specimens** tested

Use the QR-code to download the complete manual!

www.rothoblaas.com



XYLOFON WASHER

SEPARATING WASHER FOR TIMBER SCREW AND WHT

ACOUSTIC PERFORMANCE

It improves soundproofing by decoupling of timber-to-timber joints made with screws and WHT.

STATICS

The washer increases the rope effect in the connection, thus improving the static performance of the detail.



CODES AND DIMENSIONS

SEPARATING WASHER FOR SCREWS

CODE	d _{SCREW}	d _{ext} [mm]	d _{int} [mm]	s [mm]	d _{ext} [in]	d _{int} [in]	s [in]	pcs
XYLW803811	Ø8 - Ø10 5/16 - 3/8	38	11	6,0	1 1/2	7/16	1/4	50

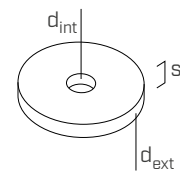

SEPARATING WASHER FOR WHT

CODE	WHT	Ø [mm]	P [mm]	B [mm]	s [mm]	Ø [in]	P [in]	B [in]	s [in]	pcs
XYLW806060	WHT340									10
	WHT440	23	60	60	6,0	7/8	2 3/8	2 3/8	1/4	
	WHT540									
XYLW808080	WHT620	27	80	80	6,0	1 1/16	3 1/8	3 1/8	1/4	10
XYLW8080140	WHT740	30	80	140	6,0	1 3/16	3 1/8	5 1/2	1/4	1

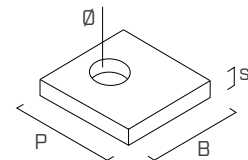

RELATED PRODUCTS



HBS
COUNTERSUNK SCREW FOR WOOD



ULS 440
WASHER



WHT
ANGLE BRACKET FOR TENSILE LOADS

For more information on the products, go to www.rothoblaas.com.



TESTED

The static performance was tested at the University of Innsbruck for use in safe static calculations.

SAFE

Thanks to its polyurethane blend (80 shore), it is extremely chemically stable and resistant to creep deformation.

XYLOFON WASHER | Tests performed

EXPERIMENTAL INVESTIGATION

Through experimental testing and analytical approaches, the mechanical and deformation performance of connections made with HBS 8x280 screws between CLT panels installed with or without XYLOFON WASHER separating washers was analysed.

TEST [T-X]
(CLT - XYLOFON35 - CLT)

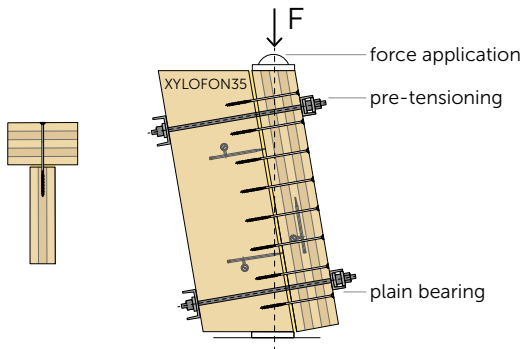

SERIES	$F_{mean}^{(1)}$ [kN]	$F_{R,k}$ [kN]	pre-tens. ⁽²⁾ [kN]	K_{ser} [N/mm]	K_u [N/mm]
T-X	54,4	40,1	0	7114	3629
	70,9	60,5	30	9540	4726

TEST [T-X-W]
(CLT - XYLOFON35 + XYLOFON WASHER - CLT)

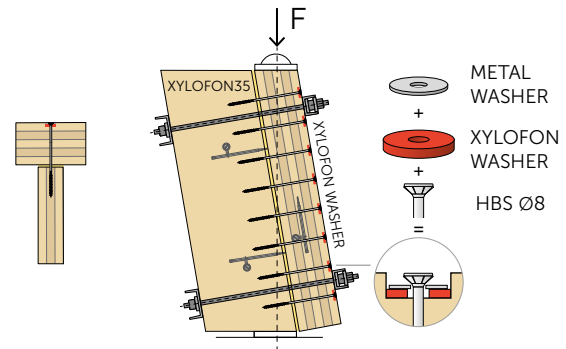

SERIES	$F_{mean}^{(1)}$ [kN]	$F_{R,k}$ [kN]	pre-tens. ⁽²⁾ [kN]	K_{ser} [N/mm]	K_u [N/mm]
T-X-W	65,0	48,3	0	6286	4330
	76,2	63,4	30	7997	5080

⁽¹⁾ Average value for 3 tests.

⁽²⁾ Preload forces of 30 kN were applied to simulate the operating load.

By adding XYLOFON WASHER separating washers, there is an increase $F_{R,k}$ related to the increase of the axial resistance of the connection (rope effect).

Use the QR-code to download the complete manual!

www.rothoblaas.com

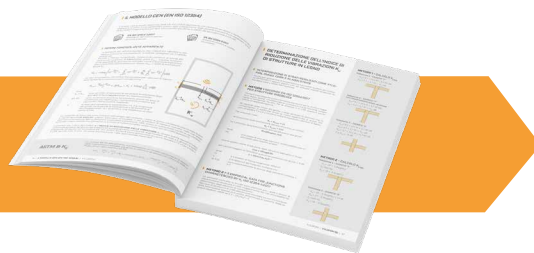

PERFORMANCE

Acoustic performance

$$K_{ij} = 18 \text{ dB}$$

K_{ij} : vibration reduction index (data estimated from experimental measurements)

See the manual for more information on configuration.

XYLOFON PLATE

FLANKSOUND
EN ISO 10848

CE
ETA-11/0496
ETA-22/0089

SEPARATING PROFILE FOR TIMBER SHEAR BRACKET ANGLES

ACOUSTIC BRIDGES

The excellent shear strength of the angle bracket and the sound-absorbing power of the profile allow acoustic bridges to be limited.

CE MARKING FROM ETA

The profile is covered by the CE marking from ETA-11/0496 and ETA-22/0089 of the angle brackets, ensuring reliability and quality.

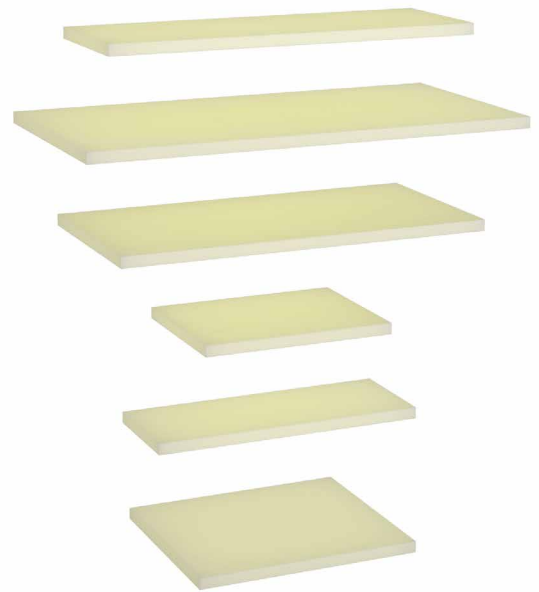

CODES AND DIMENSIONS

SEPARATING PROFILE FOR TITAN

CODE	TITAN	P	B	s	P	B	s	pcs
		[mm]	[mm]	[mm]	[in]	[in]	[in]	
XYL3570200	TTF200	70	200	6,0	2 3/4	8	1/4	10
XYL35120240	TTN240 - TTS240	120	240	6,0	4 3/4	9 1/2	1/4	10
XYL35100200	TCF200 - TCN200	100	200	6,0	4	8	1/4	10

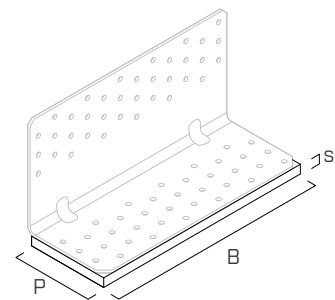

SEPARATING PROFILE FOR NINO

CODE	NINO	P	B	s	P	B	s	pcs
		[mm]	[mm]	[mm]	[in]	[in]	[in]	
XYL3580105	NINO100100	80	105	6,0	3 1/8	4 1/8	1/4	10
XYL3555150	NINO15080	55	150	6,0	2 3/16	6	1/4	10
XYL35120105	NINO100200	120	105	6,0	4 3/4	4 1/8	1/4	10

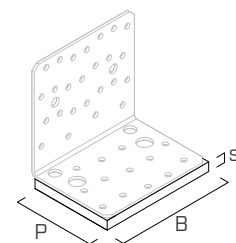

For more information on TITAN and NINO see the data sheets at www.rothblaas.com.



RANGE EXPANDED

The range has expanded with new versions for NINO, the new angle bracket unit in the Rothblaas family.

UNIFORM DEFORMATION

Thanks to the monolithic polyurethane compound, the product ensures uniform deformation in the vicinity of the connection, minimally affecting the structural performance of the connections.

MECHANICAL ACOUSTIC BEHAVIOUR

TITAN and NINO angle brackets, with a resilient XYLOFON PLATE profile, were subjected to a series of tests to understand their acoustic and mechanical behaviour. The experimental campaigns carried out within the SEISMIC-Rev project and in collaboration with multiple research institutes, have shown how the characteristics of the resilient profile influence the mechanical performance of the connection. From an acoustic point of view, with the Flanksound project, it has been demonstrated that the ability to dampen vibrations through the joint is strongly influenced by the type and number of connections.

Experimental investigations and tests on **different configurations**

FLANKSOUND PROJECT

Rothoblaas invested in research projects aimed at measuring the K_{ij} vibration reduction index for a variety of CLT panel joints, with the dual objective of providing specific experimental data for the acoustic design of CLT buildings and contributing to the development of calculation methods.

Values of K_{ij} tested for 8 configurations with **TITAN SILENT** (TITAN angle bracket + XYLOFON PLATE)

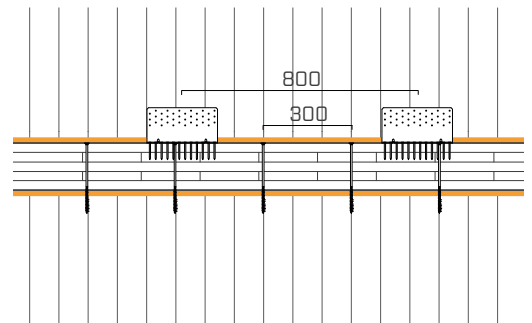

MECHANICAL BEHAVIOUR

Shear strength values tested and certified according to ETA. The specimens were brought to failure to investigate their maximum load and displacements.

Up to **34,6 kN** shear strength with **NINO** and **XYLOFON PLATE**

Use the QR-code to download the complete manual!
www.rothoblaas.com

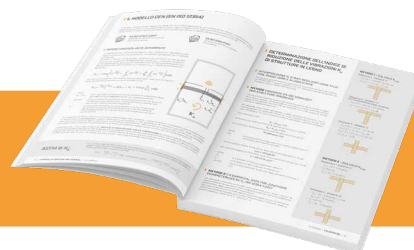

PIANO



RESILIENT SOUNDPROOFING PROFILE

CERTIFIED, PRACTICAL AND CONVENIENT

PIANO is the new resilient profile that reduces vibrations and provides good acoustic comfort, both in lightweight floors and in more complex, high-load buildings. Made of expanded and extruded EPDM blend, it is available in five versions. The elastic mix is able to compensate for expansion of the timber and structure, ensuring high durability and stability against chemical attack and UV radiation. In addition, the compact cross-section makes it more stable when crushed.

PIANO is tested and certified for use as a desolidarisation and mechanical interruption layer between building materials.

The acoustic performance tested in various applications ensures a noise reduction of 4-5 dB with a good cost-performance balance.



COMPLETE RANGE

Different versions are available to cover a wide load range, from floating floors to multi-storey buildings.

SMART

Pre-cut in some versions to obtain more widths with fewer product codes. Although it comes in various colours, it can be installed between visible elements as it masks itself in the shadow of the gap.

DURABLE

Extruded and expanded EPDM blend to optimise sound absorption. It offers high chemical stability and is VOC-free.

EASY INSTALLATION



The different colours and moulds on the profiles make it easier to choose and identify the profile, both during installation and on site. Dry installation with mechanical fastening.

CODES AND DIMENSIONS

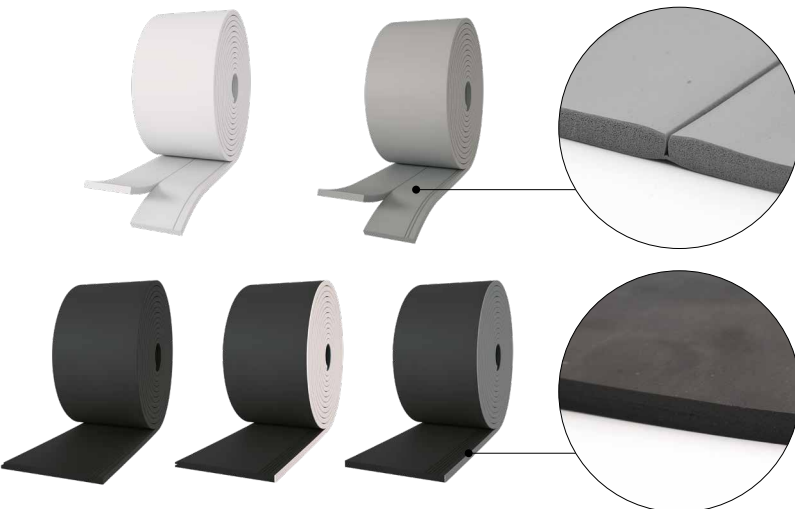
CODE	B [mm]	L [m]	s [mm]	B [in]	L [ft]	s [in]	pcs
PIANO A4040	80	10	6	3 1/8	33	1/4	1
PIANO A5050	100	10	6	4	33	1/4	1
PIANO A6060	120	10	6	4 3/4	33	1/4	1
PIANO A140	140	10	6	5 1/2	33	1/4	1
PIANO B4040	80	10	6	3 1/8	33	1/4	1
PIANO B5050	100	10	6	4	33	1/4	1
PIANO B6060	120	10	6	4 3/4	33	1/4	1
PIANO B140	140	10	6	5 1/2	33	1/4	1
PIANO C080	80	10	6	3 1/8	33	1/4	1
PIANO C100	100	10	6	4	33	1/4	1
PIANO C120	120	10	6	4 3/4	33	1/4	1
PIANO C140	140	10	6	5 1/2	33	1/4	1
PIANO D080	80	10	6	3 1/8	33	1/4	1
PIANO D100	100	10	6	4	33	1/4	1
PIANO D120	120	10	6	4 3/4	33	1/4	1
PIANO D140	140	10	6	5 1/2	33	1/4	1
PIANO E080	80	10	6	3 1/8	33	1/4	1
PIANO E100	100	10	6	4	33	1/4	1
PIANO E120	120	10	6	4 3/4	33	1/4	1
PIANO E140	140	10	6	5 1/2	33	1/4	1



PRODUCT COMPARISON

products	thickness	acoustic improvement $\Delta_{l,ij}^{(1)}$	compressive modulus E_c	acoustic load / maximum applicable load	
				acoustic load [N/mm ²]	maximum applicable load [N/mm ²]
 PIANO A	6 mm 1/4 in	> 4 dB	0,23 N/mm ² 33 psi	0,008 0,052	0,008 0,15
 PIANO B	6 mm 1/4 in	> 4 dB	1,08 N/mm ² 157 psi	0,04 0,286	0,04 0,85
 PIANO C	6 mm 1/4 in	> 4 dB	7,92 N/mm ² 1449 psi	0,26 1,4	0,26 12,07
 PIANO D	6 mm 1/4 in	> 4 dB	22,1 N/mm ² 3205 psi	1,2 2,28	1,2 16,9
 PIANO E	6 mm 1/4 in	> 4 dB	24,76 N/mm ² 3591 psi	1,8 3,2	1,8 17,07

⁽¹⁾ $\Delta_{l,ij} = K_{ij,with} - K_{ij,without}$. See the manual for more information on configuration.

LEGEND:

 load for acoustic optimisation (resonance frequency 20-30 Hz)

 compressive stress at 3 mm (ultimate limit state)

PIANO A

CODES AND DIMENSIONS

CODE	B	L	s	B	L	s	pcs
	[mm]	[m]	[mm]	[in]	[ft]	[in]	
PIANO4040	80	10	6	3 1/8	33	1/4	1
PIANO5050	100	10	6	4	33	1/4	1
PIANO6060	120	10	6	4 3/4	33	1/4	1
PIANO140	140	10	6	5 1/2	33	1/4	1

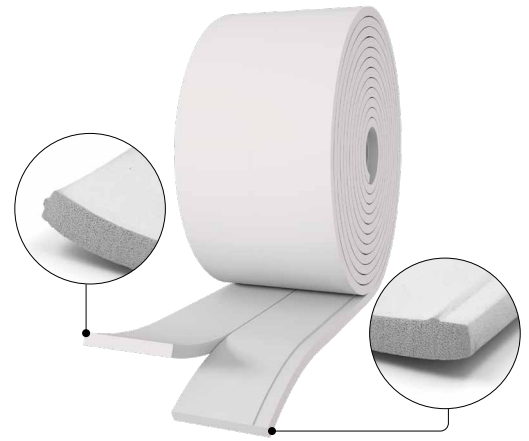

TABLE OF USE⁽¹⁾

CODE	B [mm]	load for acoustic optimisation ⁽²⁾ [kN/m] [lbf/ft]				compression for acoustic optimisation ⁽²⁾ [N/mm ²] [psi]		reduction [mm] [mil]		compressive stress at 3 mm (ultimate limit state) [N/mm ²] [psi]
		min	max	min	max	min	max			
PIANO4040	80	0,64	472	4,16	3068	0,008 1.2	0,052 7.5	0,2 8	1,35 53	0,15 22
	40 (divided)	0,32	236	2,08	1534					
PIANO5050	100	0,8	590	5,2	3835					
	50 (divided)	0,4	295	2,6	1918					
PIANO6060	120	0,96	708	6,24	4602					
	60 (divided)	0,48	354	3,12	2301					
PIANO140	140	1,12	826	7,28	5369					

⁽¹⁾The load ranges reported here are optimised with respect to the acoustic and static behaviour of the material in compression. However, it is possible to use profiles with loads outside the indicated range if the resonance frequency of the system and the deformation of the profile at the ultimate limit state are assessed. See the manual for transmissibility and attenuation graphs.

⁽²⁾Resilient profiles must be properly loaded in order to isolate medium/low frequency vibrations transmitted structurally. It is advisable to assess the load according to the operating conditions because the building must be acoustically insulated under everyday load conditions (add the value of the permanent load to 50% of the characteristic value of the incidental load $Q_{linear} = q_{gk} + 0.5 q_{vk}$).

TECHNICAL DATA

Properties	standard	value	USC conversion
Acoustic improvement $\Delta_{l,ij}$ ⁽³⁾	ISO 10848	> 4 dB	-
Compressive modulus E_c	ISO 844	0,23 MPa	33 psi
Dynamic elastic modulus $E'_{10Hz - E'_{50Hz}}$	ISO 4664-1	0,5 MPa- 0,5 MPa	73 psi - 73 psi
Damping factor $\tan\delta_{10Hz} - \tan\delta_{50Hz}$	ISO 4664-1	0,19 - 0,24	-
Compressive stress at 1 mm (1/32 in) strain σ_{1mm}	ISO 844	0,04 N/mm ²	6 psi
Compressive stress at 2 mm (1/16 in) strain σ_{2mm}	ISO 844	0,08 N/mm ²	12 psi
Compressive stress at 3 mm (1/8 in) strain σ_{3mm}	ISO 844	0,15 N/mm ²	22 psi
Reaction to fire	EN 13501-1	class E	-
Water absorption after 48h	ISO 62	4,25%	-

⁽³⁾ $\Delta_{l,ij} = K_{ij,with} - K_{ij,without}$. See the manual for more information on configuration.



PERFORMANCE

Acoustic improvement tested:

$\Delta_{l,ij}$ ⁽³⁾ : > 4 dB

Maximum applicable load
(deformation 3 mm):

0,15 N/mm²

Acoustic load:

from **0,008** to **0,052 N/mm²**

PIANO B

CODES AND DIMENSIONS

CODE	B	L	s	B	L	s	pcs
	[mm]	[m]	[mm]	[in]	[ft]	[in]	
PIANO B4040	80	10	6	3 1/8	33	1/4	1
PIANO B5050	100	10	6	4	33	1/4	1
PIANO B6060	120	10	6	4 3/4	33	1/4	1
PIANO B140	140	10	6	5 1/2	33	1/4	1

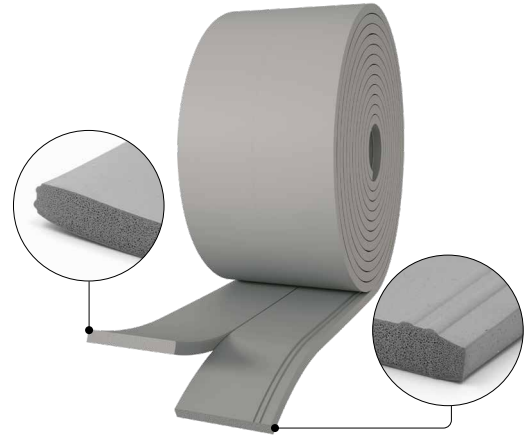

TABLE OF USE⁽¹⁾

CODE	B [mm]	load for acoustic optimisation ⁽²⁾ [kN/m] [lb/ft]				compression for acoustic optimisation ⁽²⁾ [N/mm ²] [psi]		reduction [mm] [mil]		compressive stress at 3 mm (ultimate limit state) [N/mm ²] [psi]
		min	max	min	max	min	max			
PIANO B4040	80	3,2	2360	21,6	15931	0,04 5.8	0,27 39.2	0,2 8	1,49 59	0,85 123
	40 (divided)	1,6	1180	10,8	7966					
PIANO B5050	100	4	2950	27	19914					
	50 (divided)	2	1475	13,5	9957					
PIANO B6060	120	4,8	3540	32,4	23897					
	60 (divided)	2,4	1770	16,2	11949					
PIANO A140	140	5,6	4130	37,8	27880					

⁽¹⁾The load ranges reported here are optimised with respect to the acoustic and static behaviour of the material in compression. However, it is possible to use profiles with loads outside the indicated range if the resonance frequency of the system and the deformation of the profile at the ultimate limit state are assessed. See the manual for transmissibility and attenuation graphs.

⁽²⁾Resilient profiles must be properly loaded in order to isolate medium/low frequency vibrations transmitted structurally. It is advisable to assess the load according to the operating conditions because the building must be acoustically insulated under everyday load conditions (add the value of the permanent load to 50% of the characteristic value of the incidental load $Q_{linear} = q_{gk} + 0.5 q_{vk}$).

TECHNICAL DATA

Properties	standard	value	USC conversion
Acoustic improvement $\Delta_{l,ij}$ ⁽³⁾	ISO 10848	> 4 dB	-
Compressive modulus E_c	ISO 844	1,08	157 psi
Dynamic elastic modulus $E'_{10Hz} - E'_{50Hz}$	ISO 4664-1	1,9 MPa - 2,1 MPa	276 psi - 305 psi
Damping factor $\tan\delta_{10Hz} - \tan\delta_{50Hz}$	ISO 4664-1	0,3 - 0,4	-
Compressive stress at 1 mm (1/32 in) strain σ_{1mm}	ISO 844	0,14 N/mm ²	20 psi
Compressive stress at 2 mm (1/16 in) strain σ_{2mm}	ISO 844	0,31 N/mm ²	45 psi
Compressive stress at 3 mm (1/8 in) strain σ_{3mm}	ISO 844	0,85 N/mm ²	123 psi
Reaction to fire	EN 13501-1	class E	-
Water absorption after 48h	ISO 62	1,40%	-

⁽³⁾ $\Delta_{l,ij} = K_{ij,with} - K_{ij,without}$. See the manual for more information on configuration.



PERFORMANCE

Acoustic improvement tested:

$\Delta_{l,ij}$ ⁽³⁾ : > 4 dB

Maximum applicable load
(deformation 3 mm):

0,85 N/mm²

Acoustic load:

from **0,04** to **0,27 N/mm²**

PIANO C

CODES AND DIMENSIONS

CODE	B	L	s	B	L	s	pcs
	[mm]	[m]	[mm]	[in]	[ft]	[in]	
PIANOC080	80	10	6	3 1/8	33	1/4	1
PIANOC100	100	10	6	4	33	1/4	1
PIANOC120	120	10	6	4 3/4	33	1/4	1
PIANOC140	140	10	6	5 1/2	33	1/4	1



TABLE OF USE⁽¹⁾

CODE	B [mm]	load for acoustic optimisation ⁽²⁾ [kN/m] [lbf/ft]				compression for acoustic optimisation ⁽²⁾ [N/mm ²] [psi]		reduction [mm] [mil]		compressive stress at 3 mm (ultimate limit state) [N/mm ²] [psi]
		min	max	min	max	min	max			
PIANOC080	80	9,6	7081	112	82607	0,12 17,4	1,4 203,1	0,12 5	0,63 25	12,07 1751
PIANOC100	100	12	8851	140	103259					
PIANOC120	120	14,4	10621	168	123910					
PIANOC140	140	16,8	12391	196	144562					

⁽¹⁾The load ranges reported here are optimised with respect to the acoustic and static behaviour of the material in compression. However, it is possible to use profiles with loads outside the indicated range if the resonance frequency of the system and the deformation of the profile at the ultimate limit state are assessed. See the manual for transmissibility and attenuation graphs.

⁽²⁾Resilient profiles must be properly loaded in order to isolate medium/low frequency vibrations transmitted structurally. It is advisable to assess the load according to the operating conditions because the building must be acoustically insulated under everyday load conditions (add the value of the permanent load to 50% of the characteristic value of the incidental load $Q_{linear} = q_{gk} + 0.5 q_{vk}$).

TECHNICAL DATA

Properties	standard	value	USC conversion
Acoustic improvement $\Delta_{l,ij}$ ⁽³⁾	ISO 10848	> 4 dB	-
Compressive modulus E_c	ISO 844	7,90 MPa	1449 psi
Dynamic elastic modulus $E'_{10Hz - E'_{50Hz}}$	ISO 4664-1	9,91 MPa - 11,61 MPa	1437 psi - 1684 psi
Damping factor $\tan\delta_{10Hz} - \tan\delta_{50Hz}$	ISO 4664-1	0,3 - 0,3	-
Compressive stress at 1 mm (1/32 in) strain σ_{1mm}	ISO 844	1,50 N/mm ²	218 psi
Compressive stress at 2 mm (1/16 in) strain σ_{2mm}	ISO 844	3,55 N/mm ²	514 psi
Compressive stress at 3 mm (1/8 in) strain σ_{3mm}	ISO 844	9,23 N/mm ²	1339 psi
Reaction to fire	EN 13501-1	class E	-
Water absorption after 48h	ISO 62	< 1%	-

⁽³⁾ $\Delta_{l,ij} = K_{ij,with} - K_{ij,without}$. See the manual for more information on configuration.



PERFORMANCE

Acoustic improvement tested:

$$\Delta_{l,ij}^{(3)} : > 4 \text{ dB}$$

Maximum applicable load
(deformation 3 mm):

$$12,07 \text{ N/mm}^2$$

Acoustic load:

$$\text{from } 0,12 \text{ to } 1,4 \text{ N/mm}^2$$

PIANO D

CODES AND DIMENSIONS

CODE	B	L	s	B	L	s	pcs
	[mm]	[m]	[mm]	[in]	[ft]	[in]	
PIANOD080	80	10	6	3 1/8	33	1/4	1
PIANOD100	100	10	6	4	33	1/4	1
PIANOD120	120	10	6	4 3/4	33	1/4	1
PIANOD140	140	10	6	5 1/2	33	1/4	1



TABLE OF USE⁽¹⁾

CODE	B [mm]	load for acoustic optimisation ⁽²⁾ [kN/m] [lb/ft]			compression for acoustic optimisation ⁽²⁾ [N/mm ²] [psi]		reduction [mm] [mil]		compressive stress at 3 mm (ultimate limit state) [N/mm ²] [psi]	
		min	max	min	max	min	max			
PIANOD080	80	96	70806	182,4	134531					
PIANOD100	100	120	88507	228	168164	1,2	2,28	0,33	0,62	16,9 2451
PIANOD120	120	144	106209	273,6	201797	174	330.7	13	24	
PIANOD140	140	168	123910	319,2	235430					

⁽¹⁾The load ranges reported here are optimised with respect to the acoustic and static behaviour of the material in compression. However, it is possible to use profiles with loads outside the indicated range if the resonance frequency of the system and the deformation of the profile at the ultimate limit state are assessed. See the manual for transmissibility and attenuation graphs.

⁽²⁾Resilient profiles must be properly loaded in order to isolate medium/low frequency vibrations transmitted structurally. It is advisable to assess the load according to the operating conditions because the building must be acoustically insulated under everyday load conditions (add the value of the permanent load to 50% of the characteristic value of the incidental load $Q_{linear} = q_{gk} + 0.5 q_{vk}$).

TECHNICAL DATA

Properties	standard	value	USC conversion
Acoustic improvement $\Delta_{l,ij}$ ⁽³⁾	ISO 10848	> 4 dB	-
Compressive modulus E_c	ISO 844	22,1 MPa	3205 psi
Dynamic elastic modulus $E'_{10Hz} - E'_{50Hz}$	ISO 4664-1	21,6 MPa - 26 MPa	3133 psi - 3771 psi
Damping factor $\tan\delta_{10Hz} - \tan\delta_{50Hz}$	ISO 4664-1	0,3 - 0,31	-
Compressive stress at 1 mm (1/32 in) strain σ_{1mm}	ISO 844	4,4 N/mm ²	638 psi
Compressive stress at 2 mm (1/16 in) strain σ_{2mm}	ISO 844	10,49 N/mm ²	1521 psi
Compressive stress at 3 mm (1/8 in) strain σ_{3mm}	ISO 844	16,9 N/mm ²	2451 psi
Reaction to fire	EN 13501-1	class E	-
Water absorption after 48h	ISO 62	< 1%	-

⁽³⁾ $\Delta_{l,ij} = K_{ij,with} - K_{ij,without}$. See the manual for more information on configuration.



PERFORMANCE

Acoustic improvement tested:

$\Delta_{l,ij}$ ⁽³⁾ : > 4 dB

Maximum applicable load
(deformation 3 mm):

16,9 N/mm²

Acoustic load:

from **1,2** to **2,28 N/mm²**

PIANO E

CODES AND DIMENSIONS

CODE	B	L	s	B	L	s	pcs
	[mm]	[m]	[mm]	[in]	[ft]	[in]	
PIANOE080	80	10	6	3 1/8	33	1/4	1
PIANOE100	100	10	6	4	33	1/4	1
PIANOE120	120	10	6	4 3/4	33	1/4	1
PIANOE140	140	10	6	5 1/2	33	1/4	1



TABLE OF USE⁽¹⁾

CODE	B [mm]	load for acoustic optimisation ⁽²⁾ [kN/m] [lb/ft]				compression for acoustic optimisation ⁽²⁾ [N/mm ²] [psi]		reduction [mm] [mil]		compressive stress at 3 mm (ultimate limit state) [N/mm ²] [psi]
		min	max	min	max	min	max			
PIANOE080	80	144	106209	256	188816					
PIANOE100	100	180	132761	320	236020	1,8	3,2	0,44	0,77	17,07 2476
PIANOE120	120	216	159313	384	283224	261.1	464.1	17	30	
PIANOE140	140	252	185866	448	330428					

⁽¹⁾The load ranges reported here are optimised with respect to the acoustic and static behaviour of the material in compression. However, it is possible to use profiles with loads outside the indicated range if the resonance frequency of the system and the deformation of the profile at the ultimate limit state are assessed. See the manual for transmissibility and attenuation graphs.

⁽²⁾Resilient profiles must be properly loaded in order to isolate medium/low frequency vibrations transmitted structurally. It is advisable to assess the load according to the operating conditions because the building must be acoustically insulated under everyday load conditions (add the value of the permanent load to 50% of the characteristic value of the incidental load $Q_{linear} = q_{gk} + 0.5 q_{vk}$).

TECHNICAL DATA

Properties	standard	value	USC conversion
Acoustic improvement $\Delta_{l,ij}$ ⁽³⁾	ISO 10848	> 4 dB	-
Compressive modulus E_c	ISO 844	24,76 MPa	3591 psi
Dynamic elastic modulus $E'_{10Hz - E'_{50Hz}}$	ISO 4664-1	58,3 - 67 MPa	8456 psi - 9718 psi
Damping factor $\tan\delta_{10Hz} - \tan\delta_{50Hz}$	ISO 4664-1	0,24 - 0,25	-
Compressive stress at 1 mm (1/32 in) strain σ_{1mm}	ISO 844	3,81 N/mm ²	553 psi
Compressive stress at 2 mm (1/16 in) strain σ_{2mm}	ISO 844	8,36 N/mm ²	1213 psi
Compressive stress at 3 mm (1/8 in) strain σ_{3mm}	ISO 844	17,07 N/mm ²	2476 psi
Reaction to fire	EN 13501-1	class E	-
Water absorption after 48h	ISO 62	< 1%	-

⁽³⁾ $\Delta_{l,ij} = K_{ij,with} - K_{ij,without}$. See the manual for more information on configuration.

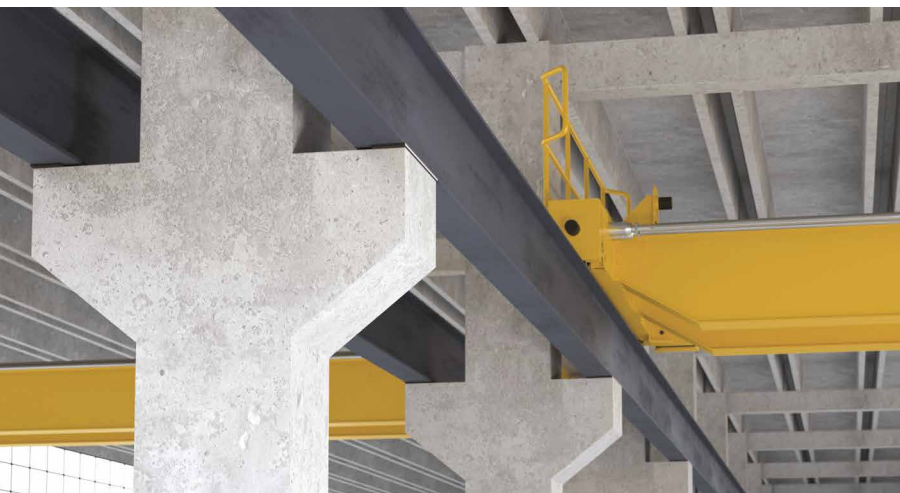

PERFORMANCE

Acoustic improvement tested:

$$\Delta_{l,ij}^{(3)} : > 4 \text{ dB}$$

Maximum applicable load
(deformation 3 mm):

$$17,07 \text{ N/mm}^2$$

Acoustic load:

$$\text{from } 1,8 \text{ to } 3,2 \text{ N/mm}^2$$

PIANO | Recommendations for installation

APPLICATION WITH STAPLES



APPLICATION WITH PRIMER SPRAY

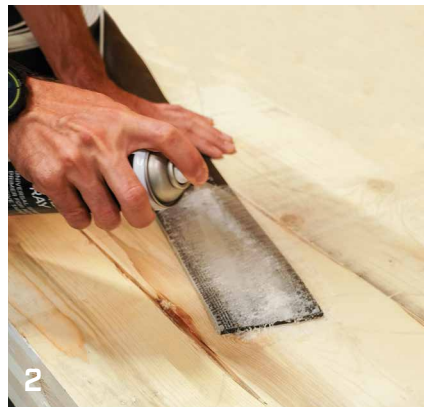

APPLICATION WITH DOUBLE BAND

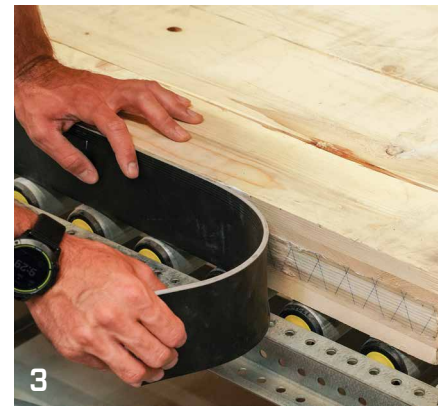
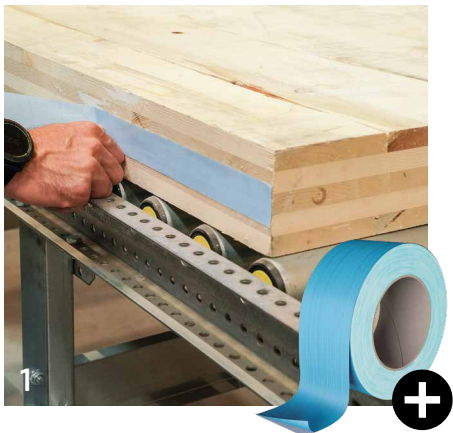

APPLICATION ON BATTENS



EUROPEAN TECHNICAL ASSESSMENT

The European Technical Assessment (ETA) provides an independent Europe-wide procedure for assessing the essential performance characteristics of non-standard construction products.

- Certified values for application as a resilient profile within structures
- K_{ij} measured for all hardnesses

$$\Delta_{l,ij} > 4 \text{ dB}$$

ANTI-VIBRATION

PIANO dampens vibrations in both static and dynamic conditions due to its ability to absorb and dissipate the energy of the system.

Theoretical reduction of **up to 10 dB** when used as a vibration damper

- Application with static loads (e.g. buildings)
- Application with dynamic loads (e.g. machines, bridges)

STATICS AND ACOUSTICS

Rothoblaas promoted a research campaign aimed at characterising the mechanical behaviour of connections in the presence of the resilient profile. Thanks to this project, it was also possible to learn about the influence of PIANO in shear connections and to optimise thickness and material type in order to ensure a perfect cost/performance ratio.

- Influence of PIANO in the presence of screws and nails
- Testing of timber-to-timber joints

possibility of knowing the influence of PIANO in **shear connections**

Use the QR-code to download the complete manual!
www.rothoblaas.com

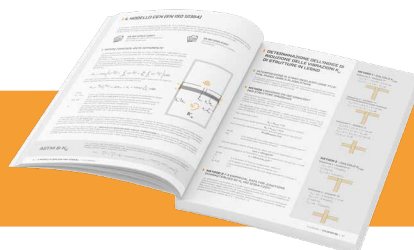

CORK

ECOLOGICAL PANEL FOR ACOUSTIC INSULATION



SUSTAINABLE BUILDING

It significantly reduces the transmission of airborne and structural noise. Natural VOC-free cork is ideal for structures where the goal is to minimise environmental impacts during construction.

PACKAGING

Marketed both in 10 x 100 cm strips and in 50 x 100 cm panels that can be easily shaped. It can be used as a wall profile or floor layer.

TESTED

Natural cork agglomerate mechanically tested by Industrial Research Centre of the University of Bologna.

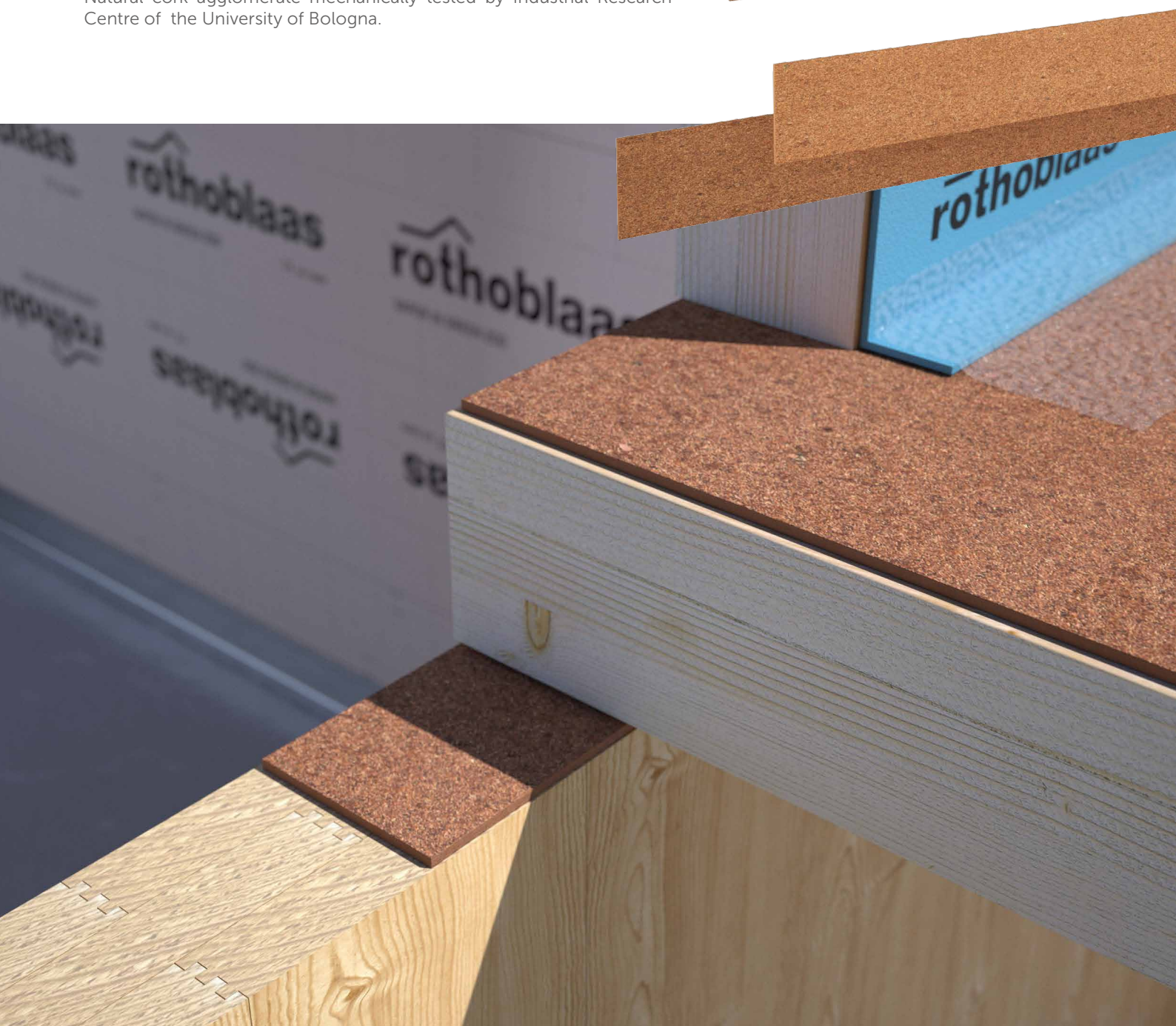

CODES AND DIMENSIONS

CODE	version	B	L	s	B	L	s	pcs
		[mm]	[m]	[mm]	[in]	[in]	[in]	
CORK410	SOFT	500	1	5	19 3/4	39 3/8	3/16	1
CORK410100	(410 kg/m ³)	100	1	5	4	39 3/8	3/16	1
CORK850	HARD	500	1	5	19 3/4	39 3/8	3/16	1
CORK850100	(850 kg/m ³)	100	1	5	4	39 3/8	3/16	1

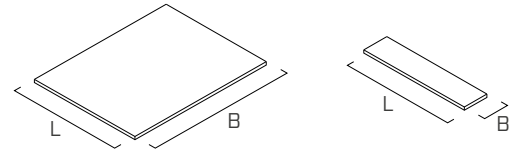

TABLE OF USE⁽¹⁾

CODE	B [mm]	load for acoustic optimisation ⁽²⁾ [kN/m] [lbf/ft]				compression for acoustic optimisation ⁽²⁾ [N/mm ²] [psi]				reduction [mm] [mil]			
		min	max		min	max		min	max				
CORK410	100	20	14751	75	55317	0,2	29	0,75	109	0,25	10	1,5	59
CORK850	100	75	55317	300	221269	0,75	109	3	435	0,25	10	1	39

⁽¹⁾The load ranges reported here are optimised with respect to the static behaviour of the material assessed under compression, considering the effect of friction and the system resonance frequency, which falls between 20 and 30 Hz, with a maximum deformation of 12%. See the manual or use MyProject to view transmissibility and attenuation graphs.

⁽²⁾Resilient profiles must be properly loaded in order to isolate medium/low frequency vibrations transmitted structurally. It is advisable to assess the load according to the operating conditions because the building must be acoustically insulated under everyday load conditions (add the value of the permanent load to 50% of the characteristic value of the incidental load $Q_{linear} = q_{gk} + 0.5 q_{vk}$).

TECHNICAL DATA

CORK SOFT (410 kg/m³) [0.24 oz/in³]

Properties	standard	value	USC conversion
Dynamic stiffness s'	UNI 29052	246 MN/m ³	-
Density	-	410 kg/m ³	0.24 oz/in ³
Maximum permissible load	-	0,75 N/mm ²	109 psi
Tensile strength	-	1,25 N/mm ²	181 psi
Water absorption 48h	-	15%	-
Reaction to fire	EN 13501-1	class E	-
Max processing temperature	-	≥ 100°C	-

CORK HARD (850 kg/m³) [0.49 oz/in³]

Properties	standard	value	USC conversion
Dynamic stiffness s'	UNI 29052	1211 MN/m ³	-
Density	-	850 kg/m ³	0.49 oz/in ³
Maximum permissible load	-	6,5 N/mm ²	943 psi
Tensile strength	-	1,5 N/mm ²	218 psi
Water absorption 48h	-	15%	-
Reaction to fire	EN 13501-1	class E	-
Max processing temperature	-	≥ 100°C	-

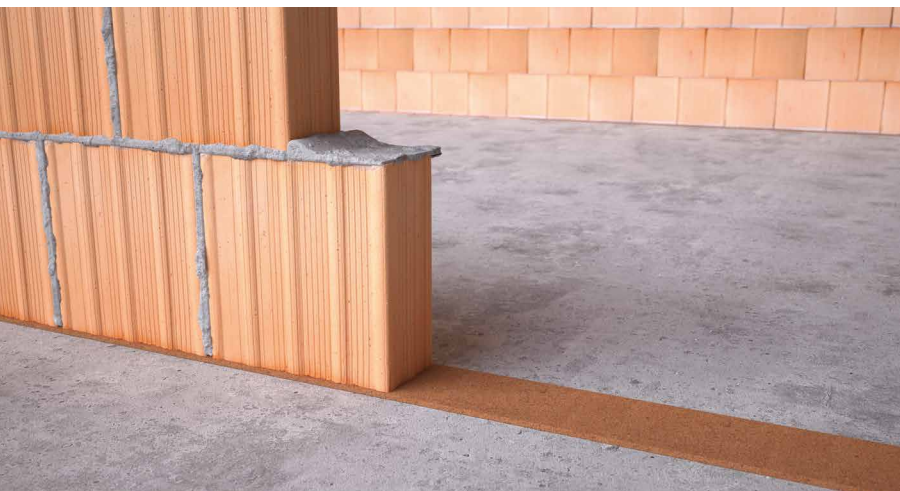

LIVING COMFORT

The compactness of the cork agglomerate makes it waterproof, so it can be used both on concrete and masonry for protection against rising damp and as a wall barrier.



ALADIN

RESILIENT SOUNDPROOFING PROFILE

TESTED, SMART AND ECONOMICAL

Despite a reduced thickness of use, the soundproofing profile ALADIN STRIPE offers an effective reduction of noise from footsteps, verified and approved in accordance with the standard EN ISO 10848 both by the certification body Holzforschung Austria, and by the Industrial Research Centre of the University of Bologna.

It is precut to obtain four different widths with only two versions: ALADIN STRIPE SOFT in compact extruded EPDM and ALADIN STRIPE EXTRA SOFT in expanded EPDM.

The product has been also tested for fire performance, achieving class E.

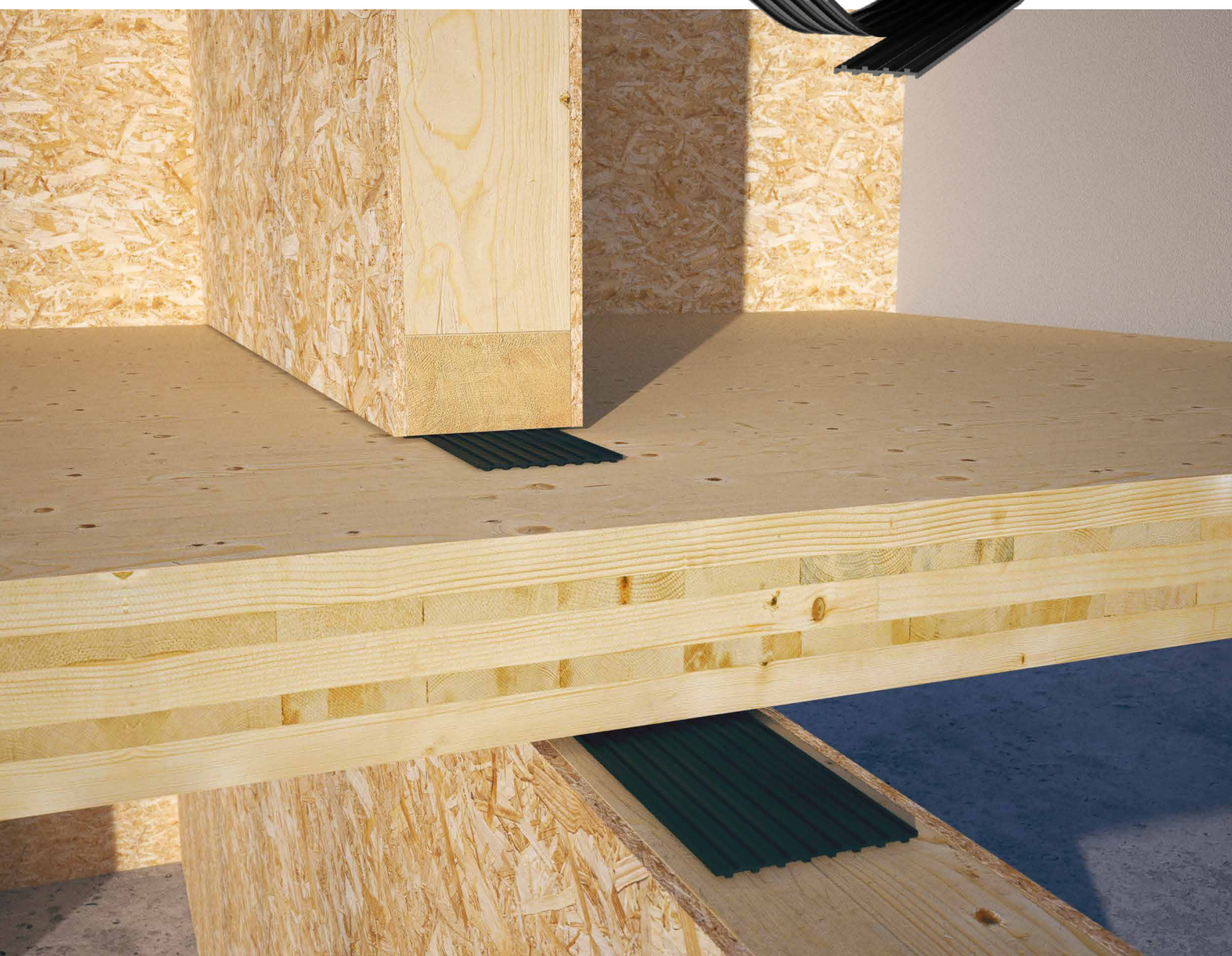

HIGH PERFORMANCE

Soundproofing up to 4 dB in accordance with EN ISO 140-7, thanks to the innovative composition of the mixture; reduced application thickness.

PRACTICAL

Pre-cut to obtain 4 different widths with only two versions. Dry installation with mechanical fastening.

RELIABLE

Extruded and expanded EPDM blend to optimise sound absorption. It also offers high chemical stability and is VOC-free.

CODES AND DIMENSIONS

CODE	version	B	L	s	B	L	s	pcs
		[mm]	[m]	[mm]	[in]	[ft]	[in]	
ALADIN115	EXTRA SOFT	115	50	7	4 1/2	164	9/32	1
ALADIN95	SOFT	95	50	5	3 3/4	164	3/16	1

ALADIN EXTRA SOFT

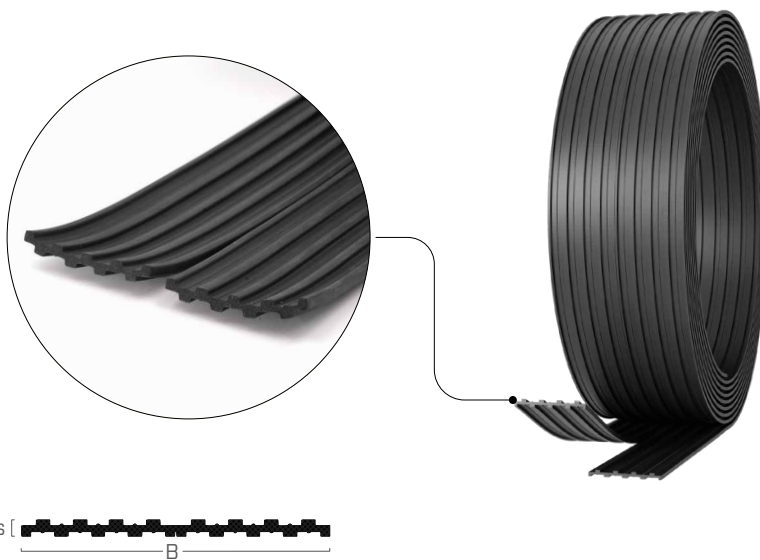

ALADIN SOFT

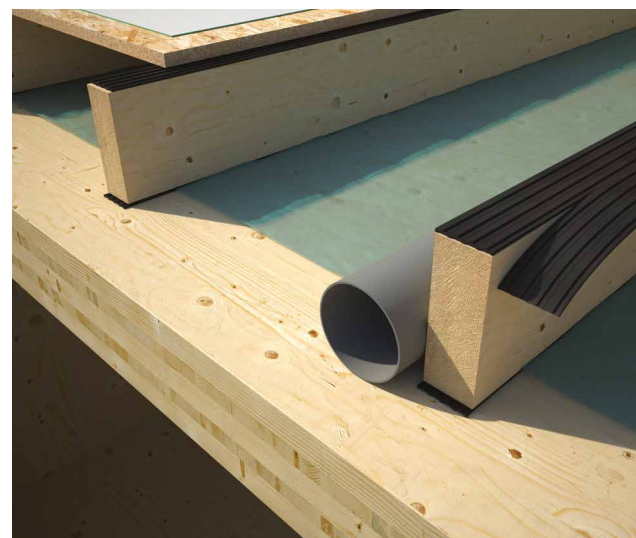
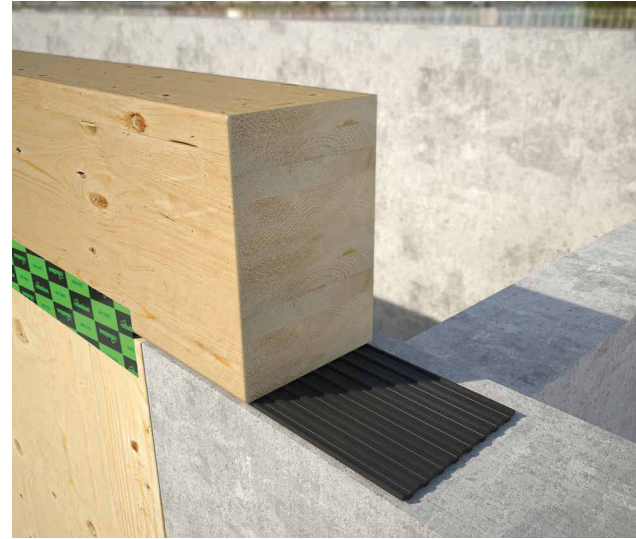
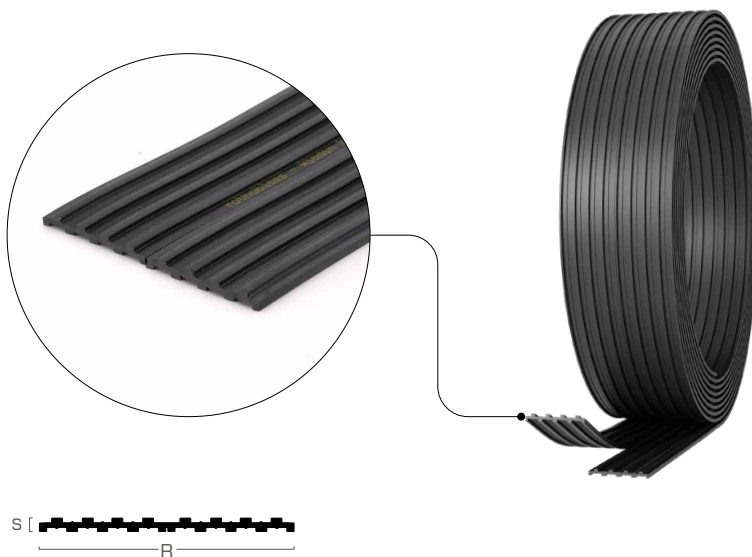

ALADIN EXTRA SOFT

TABLE OF USE⁽¹⁾

CODE	B		load for acoustic optimisation ⁽²⁾ [kN/m] [lbf/ft]				compression for acoustic optimisation ⁽²⁾ [N/mm ²] [psi]		reduction [mm] [mil]	
	[mm]	[in]	from	a			from	a	from	a
ALADIN115	115	4 1/2	4	2969	18	13317	0,035	0,157	0,7	2
	57,5 (divided)	2 1/4	2	1484	9	6658	5.1	22.8	28	79

⁽¹⁾See the manual or use MyProject to view transmissibility and attenuation graphs.

⁽²⁾Resilient profiles must be properly loaded in order to isolate medium/low frequency vibrations transmitted structurally. It is advisable to assess the load according to the operating conditions because the building must be acoustically insulated under everyday load conditions (add the value of the permanent load to 50% of the characteristic value of the incidental load $Q_{linear} = q_{gk} + 0.5 q_{vk}$).

TECHNICAL DATA

Properties	standard	value
Acoustic improvement $\Delta L'_{nT,w}$ ⁽³⁾	ISO 10848	4 dB
Dynamic stiffness s' (airtight condition) ⁽⁴⁾	UNI 29052	76 MN/m ³
Dynamic stiffness s' (non-airtight condition) ⁽⁴⁾	UNI 29052	23 MN/m ³
Density	ASTM D 297	0,50 g/cm ³
Compression set 50% (22h, 23°C)	EN ISO 815	≤ 25%
Compression set 50% (22h, 40°C)	EN ISO 815	≤ 35%
Water absorption 48h	-	3%
Reaction to fire	EN 13501-1	class E
Max processing temperature	-	100°C

⁽³⁾See the manual for more information on configuration.

⁽⁴⁾The standard requires for measurement with loads between 0.4 and 4 kPa and not with the product operating load. The contribution of air is not calculated because the product is extremely impermeable to air (extremely high flow resistance figures).

ALADIN SOFT

TABLE OF USE⁽¹⁾

CODE	B		load for acoustic optimisation ⁽²⁾ [kN/m] [lbf/ft]				compression for acoustic optimisation ⁽²⁾ [N/mm ²] [psi]		reduction [mm] [mil]	
	[mm]	[in]	from	a			from	a	from	a
ALADIN95	95	3 3/4	18	13243	30	22142	0,189	0,316	0,5	1,5
	47,5 (divided)		9	6621	15	11071	27.4	45.8	20	59

⁽¹⁾See the manual or use MyProject to view transmissibility and attenuation graphs.

⁽²⁾Resilient profiles must be properly loaded in order to isolate medium/low frequency vibrations transmitted structurally. It is advisable to assess the load according to the operating conditions because the building must be acoustically insulated under everyday load conditions (add the value of the permanent load to 50% of the characteristic value of the incidental load $Q_{linear} = q_{gk} + 0.5 q_{vk}$).

TECHNICAL DATA

Properties	standard	value
Acoustic improvement $\Delta L'_{nT,w}$ ⁽³⁾	ISO 10848	3 dB
Dynamic stiffness s' (airtight condition) ⁽⁴⁾	UNI 29052	221 MN/m ³
Dynamic stiffness s' (non-airtight condition) ⁽⁴⁾	UNI 29052	115 MN/m ³
Density	ASTM D 297	1,1 g/cm ³
Compression set 50% (22h, 70°C)	EN ISO 815	50%
Tensile strength	EN ISO 37	≥ 9 N/mm ²
Elongation at failure	EN ISO 37	≥ 500%
Water absorption 48h	-	< 1%
Reaction to fire	EN 13501-1	class E
Max processing temperature	-	100°C

⁽³⁾See the manual for more information on configuration.

⁽⁴⁾The standard requires for measurement with loads between 0.4 and 4 kPa and not with the product operating load. The contribution of air is not calculated because the product is extremely impermeable to air (extremely high flow resistance figures).

INTEGRATED DESIGN - FLANKSOUND PROJECT

Rothoblaas has promoted research projects aimed at measuring the K_{ij} vibration reduction index for a variety of CLT panel joints, with the dual objective of providing specific experimental data for the acoustic design and contributing to the development of calculation methods.

- influence of CLT type and thickness
- influence of type and number of screws
- influence of type and number of angle brackets and connectors
- effectiveness of ALADIN

K_{ij} measured according to ISO EN 10848

MEASUREMENTS ON SITE

In order to know the behaviour of its products inside buildings, Rothoblaas also invests in on-site measurement campaigns. The effectiveness of ALADIN has resulted in highly satisfactory impact noise levels.

$$L'_{nT,w} = 34 \text{ dB}$$
$$NIRS_{ASTM} = 75$$



STATICS AND ACOUSTICS

As part of the Seismic Rev project, in cooperation with the University of Trento and CNR IVALSA, preliminary assessment was done of the mechanical behaviour of the TITAN when paired with ALADIN.

Experimental data on the static performance of a timber-to-steel connection with ALADIN interposed

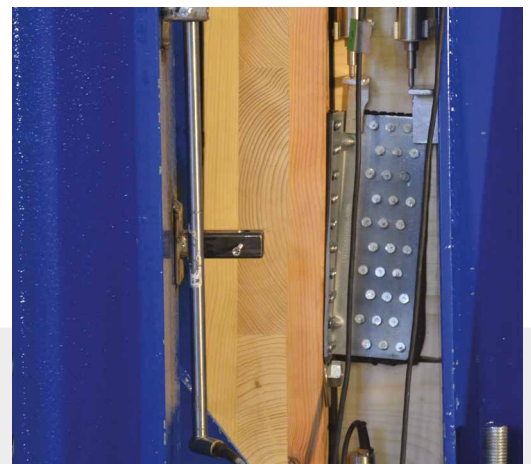

Use the QR-code to download the complete manual!

www.rothoblaas.com

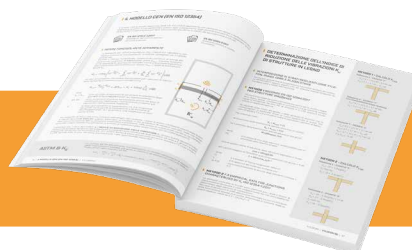

TRACK

RESILIENT SOUNDPROOFING PROFILE

COST-PERFORMANCE

Composition of the mixture optimised to provide both good performance and low cost.

FUNCTIONAL

Reduces flanking transmission of vibrations and improves airtightness.



CODES AND DIMENSIONS

CODE	B [mm]	L [m]	s [mm]	B [in]	L [ft]	s [in]	pcs
TRACK85	85	50	4,5	3 3/8	164	3/16	1



TECHNICAL DATA

Properties	standard	value
Hardness	EN ISO 868	65 ± 5 Shore A
Density	ASTM D 297	1,2 g/cm ³
Tensile strength	EN ISO 37	≥ 7,5 N/mm ²
Elongation at break point	EN ISO 37	≥ 250%
Compression set 50% (70h, 70°C)	EN ISO 815	35%
Max processing temperature	-	90 °C



MATERIAL

Synthetic rubber in compact extruded EPDM. High chemical stability, it does not contain harmful substances.

STABLE

Thanks to the solid EPDM mix, it endures over time. It is not affected by chemical attacks.

ALADIN & TRACK | Recommendations for installation

APPLICATION WITH STAPLES

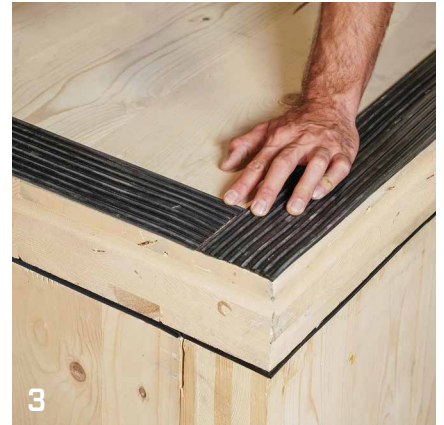
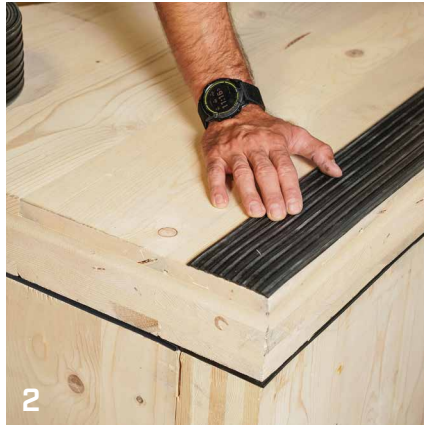

APPLICATION WITH PRIMER SPRAY



APPLICATION WITH DOUBLE BAND



GRANULO STRIPE

RESILIENT GRANULAR RUBBER SOUNDPROOFING PROFILE

ANTI-VIBRATION

The thermal-bonded rubber granules dampen vibrations, thus insulating the noise produced by footsteps.

WALL BARRIER

Resilient strip for decoupling vertical partitions from ceilings.



CODES AND DIMENSIONS

CODE	B	L	s	B	L	s	pcs
	[mm]	[m]	[mm]	[in]	[ft]	[in]	
GRANULO100	100	15	4	4	9/16	3/16	1



TECHNICAL DATA

Properties	standard	value
Hardness	-	50 shore A
Density	-	750 kg/m ³
Apparent dynamic stiffness s't	ISO 29052-1	66 MN/m ³
Theoretical estimate of the degree of footstep attenuation $\Delta L_w^{(1)}$	ISO 12354-2	22,6 dB
System resonance frequency $f_0^{(1)}$	ISO 12354-2	116.3 Hz
Compression deformation stress		
10% deformation	-	21 kPa
25% deformation	-	145 kPa
Elongation at failure	-	27 %
Thermal conductivity λ	UNI EN 12667	0,033 W/mK

⁽¹⁾Value calculated according to EN ISO 12354-2 for impact sound insulation underscreed products considering a load condition $m'=125 \text{ kg/m}^2$.



MATERIAL

Mix of natural and synthetic elastomers bound by polymerised polyurethane.

MULTIFUNCTIONAL

Also available in other formats, ideal for outdoor applications as structural substrates (PAD, ROLL and MAT).

GRANULO PAD

RESILIENT SUPPORT FOR BATTENS AND RIBS OF FLOORS OR TERRACES

CODES AND DIMENSIONS

CODE	B	L	s	B	L	s	pcs
	[mm]	[m]	[mm]	[in]	[in]	[in]	
GRANULOPAD	80	0,08	10	3 1/8	3 1/8	3/8	20



TECHNICAL DATA

Properties	standard	value
Dynamic stiffness s'	UNI 29052	48 MN/m ³
Theoretical estimate of the degree of footstep attenuation $\Delta L_w^{(1)}$	ISO 12354-2	24,2 dB
System resonance frequency $f_0^{(1)}$	ISO 12354-2	99,1 Hz

⁽¹⁾Value calculated according to EN ISO 12354-2 for impact sound insulation underscreed products considering a load condition $m'=125 \text{ kg/m}^2$.

GRANULO ROLL

RESILIENT PROFILE FOR BATTENS AND RIBS OF FLOORS OR TERRACES

CODES AND DIMENSIONS

CODE	B	L	s	B	L	s	pcs
	[mm]	[m]	[mm]	[in]	[ft]	[in]	
GRANULOROLL	80	6	8,0	3 1/8	19.7	5/16	1



TECHNICAL DATA

Properties	standard	value
Dynamic stiffness s'	UNI 29052	50 MN/m ³
Theoretical estimate of the degree of footstep attenuation $\Delta L_w^{(1)}$	ISO 12354-2	23,9 dB
System resonance frequency $f_0^{(1)}$	ISO 12354-2	101,2 Hz

⁽¹⁾Value calculated according to EN ISO 12354-2 for impact sound insulation underscreed products considering a load condition $m'=125 \text{ kg/m}^2$.

GRANULO MAT

RESILIENT SUBSTRATE FOR SCREEDS AND TERRACES

CODES AND DIMENSIONS

CODE	B	L	s	B	L	s	pcs
	[mm]	[m]	[mm]	[in]	[ft]	[in]	
GRANULOMAT	1250	10	6,0	49 3/16	33	1/4	1



TECHNICAL DATA

Properties	standard	value
Dynamic stiffness s'	UNI 29052	118 MN/m ³
Theoretical estimate of the degree of footstep attenuation $\Delta L_w^{(1)}$	ISO 12354-2	18,6 dB
System resonance frequency $f_0^{(1)}$	ISO 12354-2	155,5 Hz

⁽¹⁾Value calculated according to EN ISO 12354-2 for impact sound insulation underscreed products considering a load condition $m'=125 \text{ kg/m}^2$.

TIE-BEAM STRIPE

TIE BEAM SEALING PROFILE

ADJUSTABLE

Flexible profile is easy to work, thanks to the soft and shapeable mixture.

WATERPROOFING

Resilient profile to connect tie beam and brickwork/concrete.



CODES AND DIMENSIONS

CODE	B [mm]	L [m]	s [mm]	B [in]	L [ft]	s [in]	pcs
TIEBEAM71	71	50	9	2 3/4	164	3/8	1



TECHNICAL DATA

Properties	standard	value
Hardness	EN ISO 868	50 shore A
Density	ASTM D 297	1,1 g/cm ³
Breaking load	EN ISO 37	≥ 9 MPa
Elongation at break point	EN ISO 37	≥ 500%
Compression set 50% (22h, 100°C)	EN ISO 815	< 50%
Max processing temperature	-	90 °C
Storage temperature	-	+5 / +25 °C



SMART

The pre-formed profile adapts well to surfaces, ensuring air and water tightness at all times. It can also be used vertically as a seal between walls.

STRENGTH

Its profile ensures great elasticity and resistance even in the event of perforations and mechanical fastening, thanks to the special modified EPDM compound.

THE BEST ATTACK IS DEFENCE



A well-designed ground connection ensures the durability of your timber building and plays mainly in defence: it protects against capillary rising damp and interstitial condensation.

It integrates the ALU START aluminium ground connection system with waterproofing profiles, bituminous membranes and butyl bands. It increases the durability of the building by playing defence.

Scan the QR code and discover the technical features of waterproofing products.



www.rothoblaas.com



rothoblaas

Solutions for Building Technology

NOISE REDUCTION: STAIRS AND STAIRWELL

Stairs are often one of the critical points for noise transmission in buildings. The propagation and amplification of impact noise is often difficult to control and is linked to the particular conformation of stairs and stairwells: extremely rigid and capable of generating noise by structural means. In fact, the wall dividing the stairs from the adjacent room is often the main cause of sound diffusion between rooms.

Effective soundproofing requires a great deal of design effort, which involves analysing the different types of materials and construction techniques used. To remedy the problem, structural elements must be separated by interposing resilient profiles and the floors must be insulated with impact-absorbing membranes.

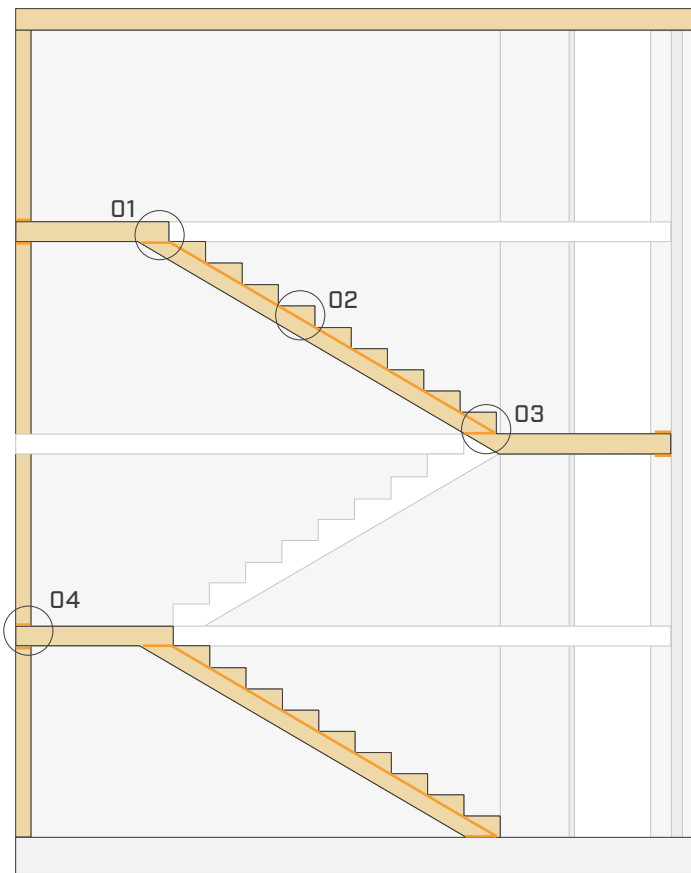

Explanatory section of timber staircase.

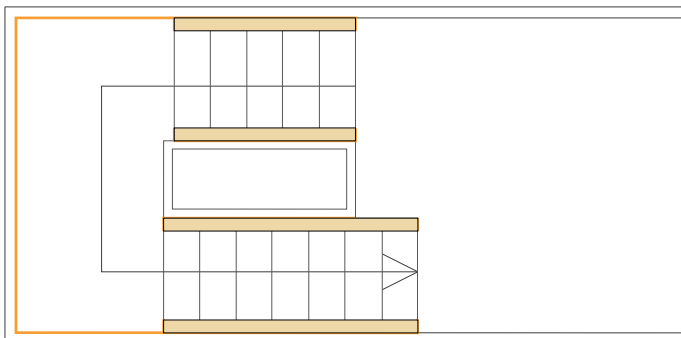

Explanatory plan of timber staircase.

01 Stair-landing arrival connection

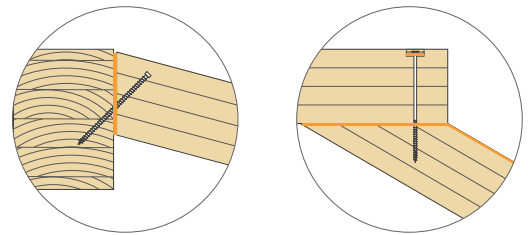

02 Step-stair structure connection

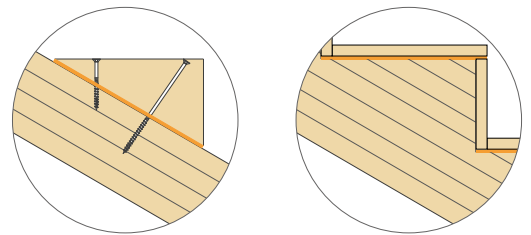

03 Stair-landing departure connection

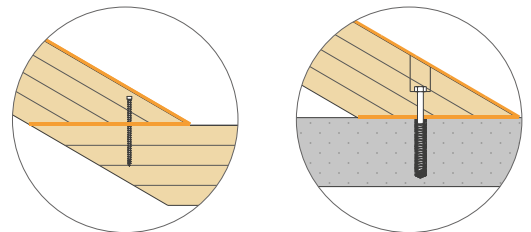

04 Landing-passing wall connection

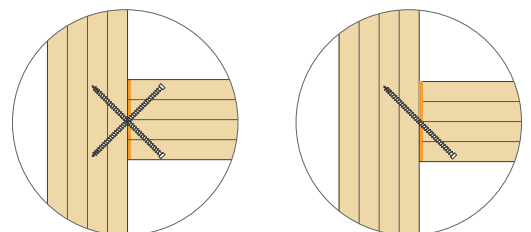

SOLID TIMBER STAIRCASE

It is common practice to make staircases of solid wood with two stringers on which the steps rest. In order to improve acoustic performance, the steps must be decoupled from the stringers and the stringers from the side walls with which they come into contact. To do this, Rothoblaas recommends **XYLOFON 20**, **PIANO A** or **ALADIN EXTRA SOFT**. In the case of prefabricated staircases, it may be useful to use a Rothoblaas PE tape to help the staircase slide into the compartment.

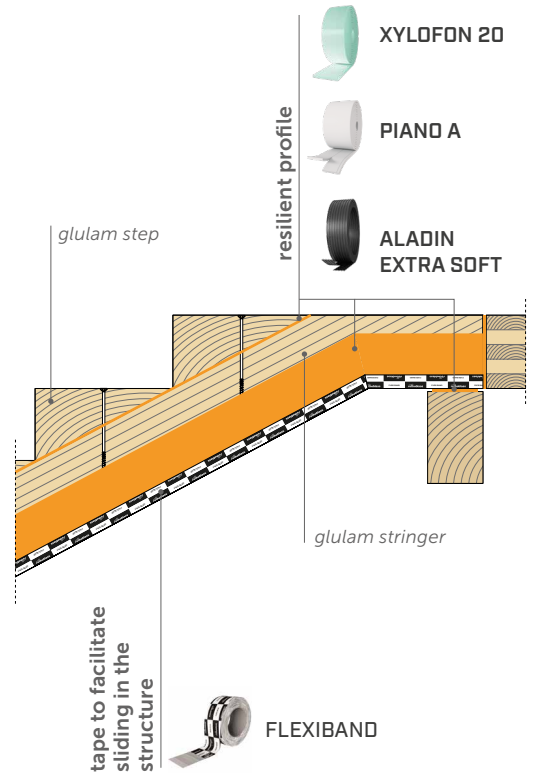

CONCRETE STAIRCASE

The problem of impact noise affects all types of stairs, including concrete ones. It is therefore important to separate the flights of stairs from landings with **XYLOFON 20**, **XYLOFON 35**, **PIANO B** or **PIANO C** and **SILENT EDGE** to reduce noise transmission to adjacent walls and floors.

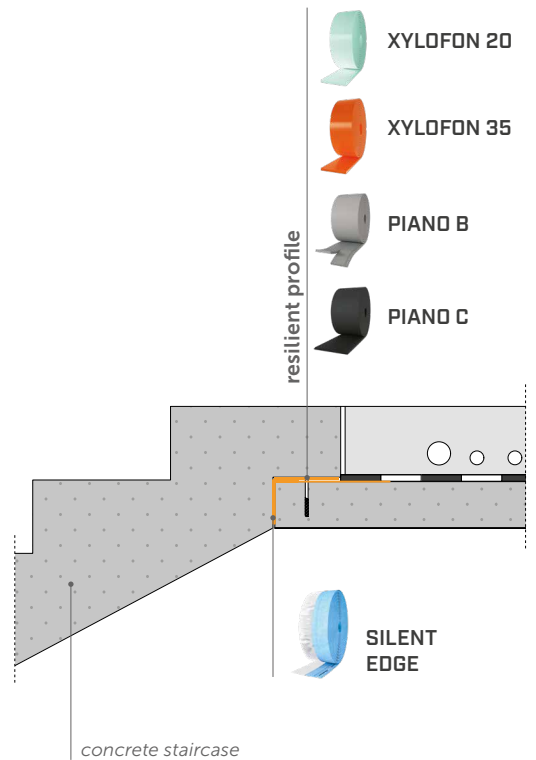
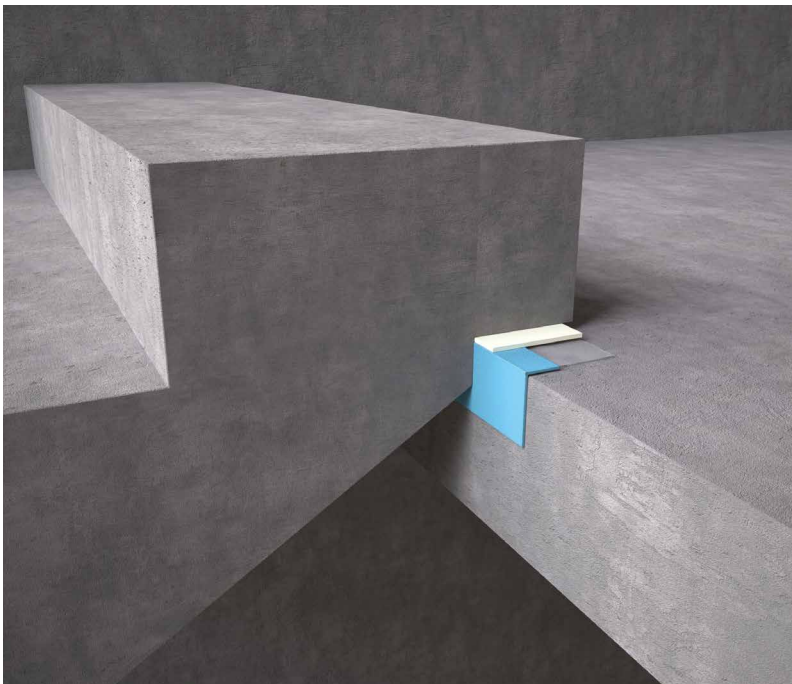

TIMBER FRAME STAIRCASE

In frame buildings, stairs are made with two moulded stringers to which risers and treads are attached. In order to improve the acoustic performance of stairs, Rothoblaas recommends using **XYLOFON**, **PIANO** or **ALADIN** to separate the structural elements (stringers, floor and walls) and **XYLOFON 20**, **PIANO A**, **ALADIN EXTRA SOFT**, **CONSTRUCTION SEALING** or **SILENT UNDERFLOOR** to separate the treads from the stringer.

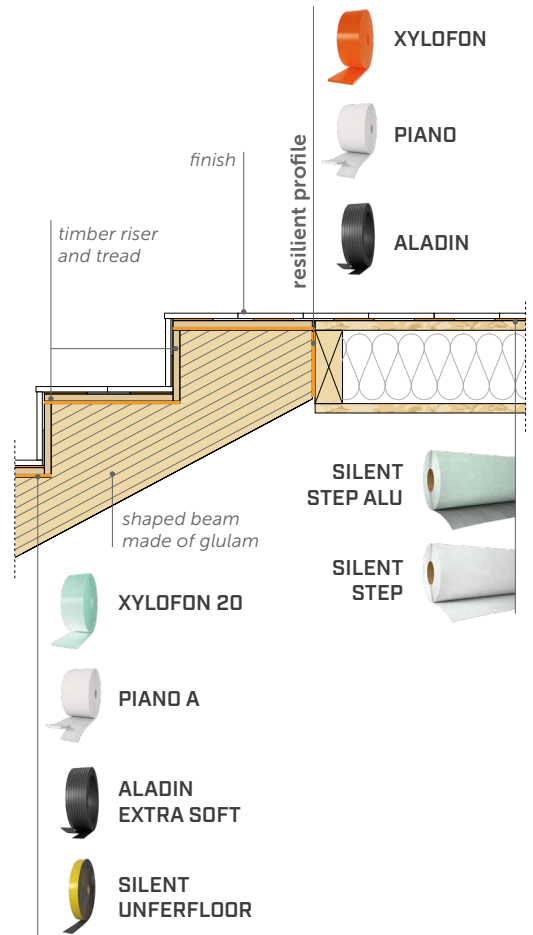

STEEL STAIRCASE

In steel staircases, as in all lightweight structures, it is essential to interrupt the propagation of vibrations. In order to have a reduction in noise transmission, it is advisable to use resilient products. **XYLOFON 20**, **XYLOFON 35**, **PIANO A** or **PIANO B** are ideal for isolating steel elements from the structure.

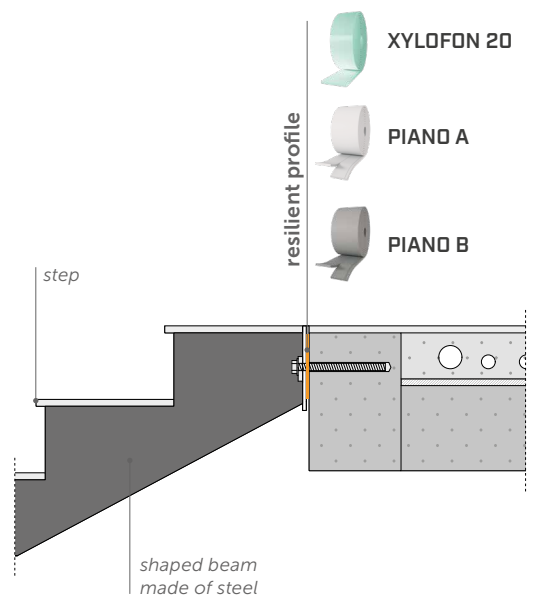

CLT STAIRCASE

It is also common for flights of stairs in CLT buildings to be constructed with a panel of CLT onto which the steps are fixed. In order to prevent the transmission of vibrations caused by walking, we recommend separating the CLT elements with **XYLOFON**, **PIANO** or **ALADIN** and separating the steps from the flight with **XYLOFON 20**; **PIANO A**, **ALADIN EXTRA SOFT** or **SILENT UNDERFLOOR**.

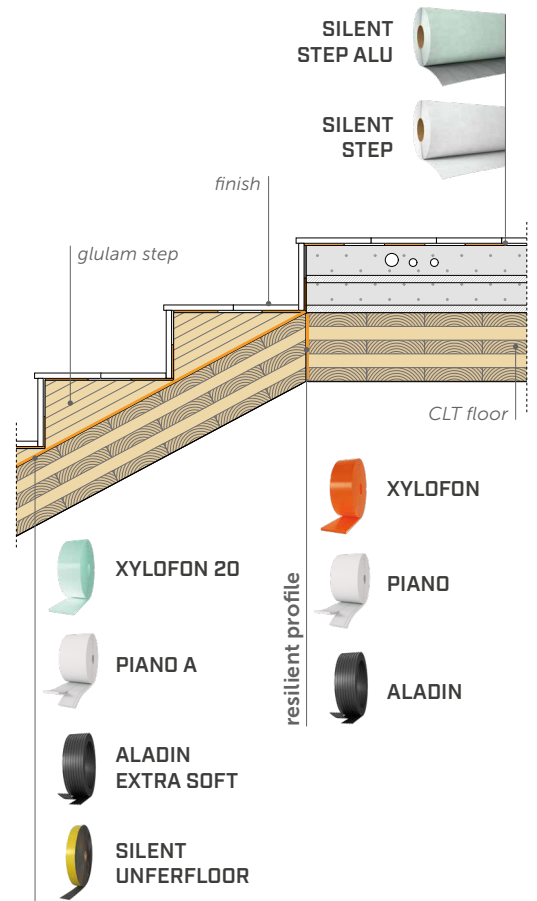
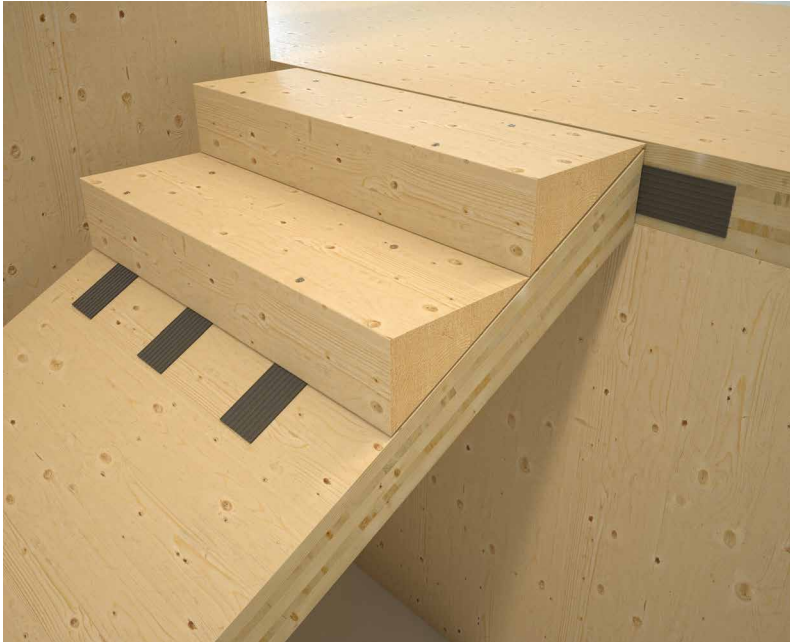

ACOUSTIC AND SEALING

ACOUSTIC AND SEALING

ACOUSTIC AND SEALING

FIRE SEALING SILICONE

*HIGH FIRE-RESISTANT SILICONE SEALANT
WITH ACOUSTIC PERFORMANCE* 140

MS SEAL

MS POLYMER HIGH ELASTICITY SEALANT 143

HERMETIC FOAM

HIGH PERFORMING SOUNDPROOFING SEALING FOAM 144

EXPAND BAND

SELF-EXPANDING SEALING TAPE 146

WINDOW BAND

*SELF-EXPANDING SEALING TAPE
FOR WINDOWS/DOORS* 148

PLASTER BAND IN/OUT

*SPECIAL HIGH-ADHESION TAPE,
CAN BE ALSO PLASTERED* 150

SMART BAND

*UNIVERSAL SINGLE-SIDED TAPE WITH
SEPARABLE LINER* 158

WINDOW/DOOR FRAMES ACOUSTICS

To ensure its effectiveness, a window/door must always be installed taking into account the principle of continuity of the wind and air tightness levels (see the "TAPES, SEALANTS AND MEMBRANES" catalogue available at www.rothoblaas.com). An improperly installed high-performance window or door frame will compromise the overall performance of the system and will not meet the needs of the end user.

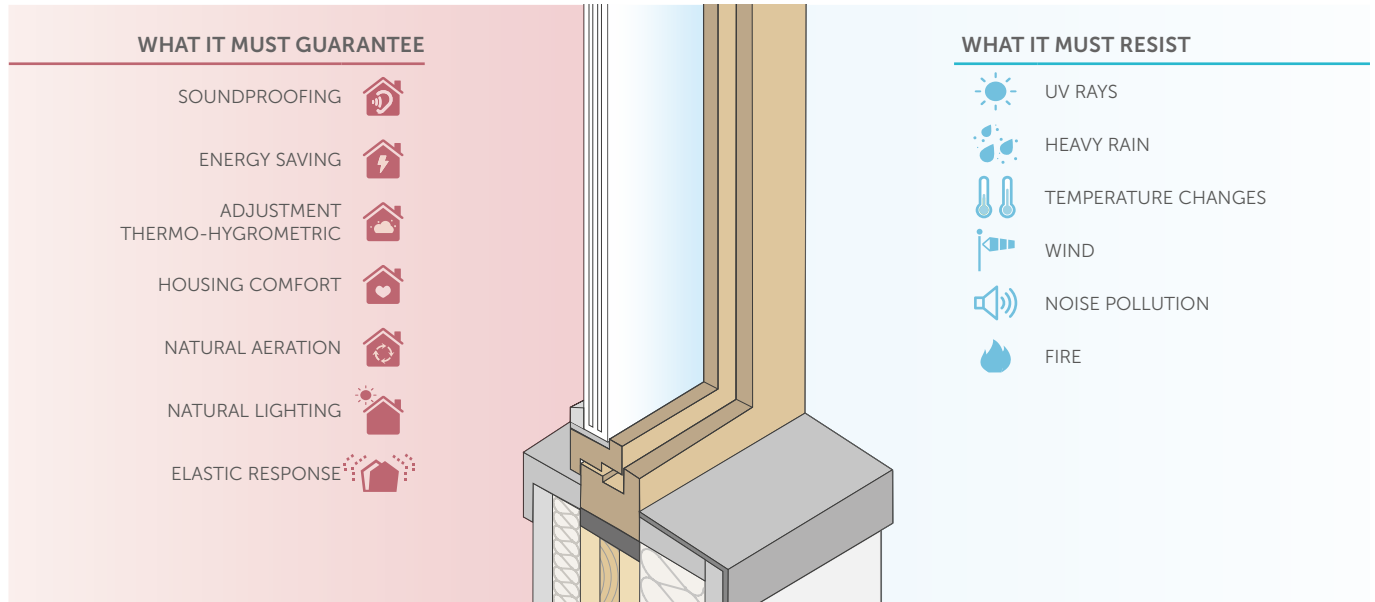

THREE LEVELS OF PROTECTION

The three level method, which is used often in most European countries, identifies the airtightness, windtightness and thermal-acoustic insulation levels for proper placement of doors and windows. To obtain maximum performance, it is important to take care in all design stages: Rothoblaas offers specific solutions for each of the three levels.

WIND TIGHTNESS LEVEL

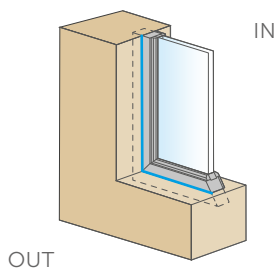

The most external level must guarantee protection against weather. If not properly treated, it can lead to problems of infiltration and accumulation of stagnant water at the bottom of the window hole.

Rothoblaas offers: START BAND, PROTECT, BYTUM BAND, FLEXI BAND, FLEXI BAND UV, FACADE BAND UV, SOLID BAND, SMART BAND, PLASTER BAND, PLASTER BAND LITE, MANICA PLASTER, TERRA BAND, ALU BUTYL BAND, BLACK BAND, MS SEAL

THERMAL AND ACOUSTIC INSULATION LEVEL

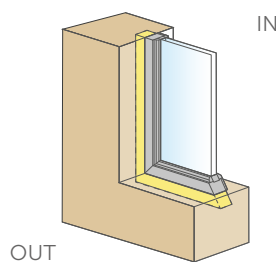

The intermediate level must guarantee thermal-acoustic performance and mechanical fixing. When choosing products, bear in mind that a good anti-noise solution is not always thermally effective.

Rothoblaas offers: EXPAND BAND, WINDOW BAND, FRAME BAND, EASY FOAM, HERMETIC FOAM, FIRE FOAM

AIRTIGHTNESS LEVEL

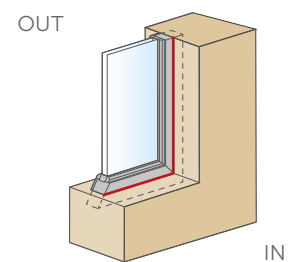

The most internal level must be airtight. Its function is to prevent the passage of vapour laden air, which could create condensation in the joints and mould on the surface.

Rothoblaas offers: SEAL BAND, FLEXI BAND, SOLID BAND, SMART BAND, PLASTER BAND, PLASTER BAND LITE, MANICA PLASTER, BLACK BAND, MS SEAL

PRIMARY JOINT AND SECONDARY JOINT

INSTALLATION WITHOUT COUNTERFRAME

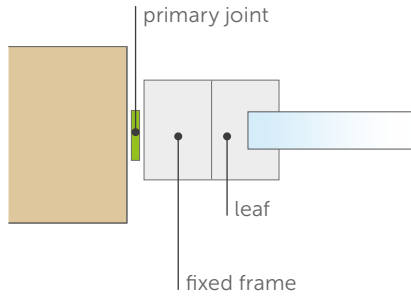

INSTALLATION WITH COUNTERFRAME

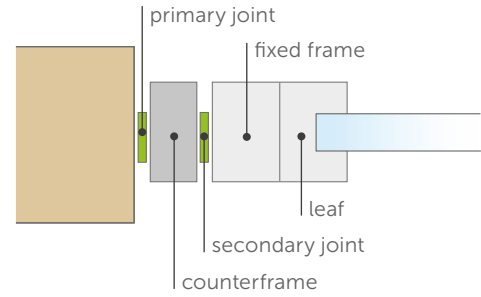

The **PRIMARY JOINT** is the first installation node between the structure and the counterframe. The **SECONDARY JOINT** is the junction between the counterframe and the frame.

CORRECT DESIGN OF THE INSTALLATION JOINT

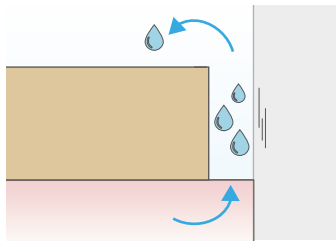

If the design or installation does not adequately take care of any of the three levels, there is a high probability of condensation and water infiltration into the structure.

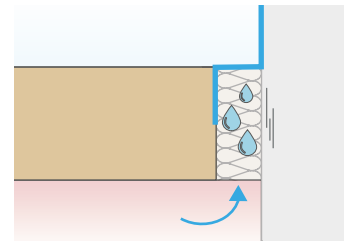

The inner protection level is not sealed, but the outer level is sealed: there is a high risk of humidity-laden internal air penetrating the joints and forming condensation in the intermediate level.

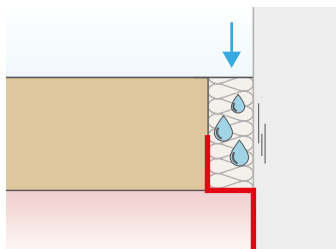

The inner protection level is sealed, the outer level is not: the joint is not effectively protected against wind and rain from outside.

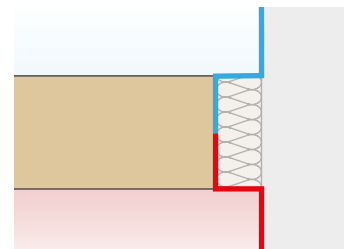

In this way, the three levels of protection are correctly designed and executed: the joint performs perfectly from an acoustic and thermo-hygrometric point of view.

AIR: MAIN MEDIUM OF PROPAGATION OF SOUND WAVES

These sound reduction index tests were carried out to study, from an acoustic point of view, the primary joint of a window/door frame-to-structure connection.

In the first graph, the curves represent the sound reduction index of the joint where a crack has been created (orange line) and the sound reduction index of the same joint after the crack has been grouted (grey line). The increase ΔR_w due to the restoration of the airtight layer is + 2 dB.

The curves in the second graph represent the sound reduction index of the same primary joint that has been sealed once with self-expanding tape type EXPAND BAND or WINDOW BAND (orange line) obtaining an R_w of 41 (-2,-4) dB and once with polyurethane foam type HERMETIC FOAM or EASY FOAM (grey line) obtaining an R_w of 40 (-1,-3) dB.

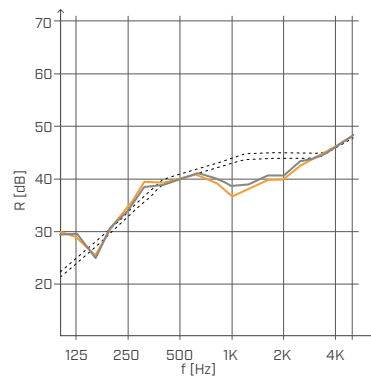

— $R_w = 39$ [-1;-4] before intervention
— $R_w = 41$ [-2;-6] after intervention

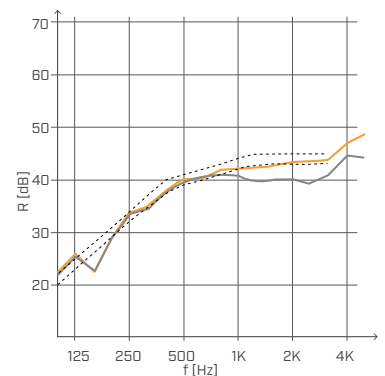

— $R_w = 41$ [-2;-4] with KOMPRI BAND or FRAME BAND
— $R_w = 40$ [-1;-3] with SEALING FOAM

THE WINDOW AND DOOR INSTALLATION PLAN AND ITS EFFECTS

Several factors determine this aspect: ranging from the building tradition of the place where the structure is built, the client's habits, the type of construction chosen. However, it is important to consider that the choice of window/door frame installation plan has an impact on the temperature trend in the construction node, and therefore on the general effectiveness of the installation. Continuity with the insulating layer that may be present in the layers of the wall should be searched for.

INTERNAL FLUSH INSTALLATION

Some traditional local systems prefer it because it allows the full opening of the window/door. However, this is not an optimal solution from a thermal point of view, as the window/door is moved inwards and the risk of low internal surface temperatures is greater.

In order to avoid thermal bridges in buildings with external insulation, it is recommended that the side walls of the window hole are also insulated to join them to the external insulation.

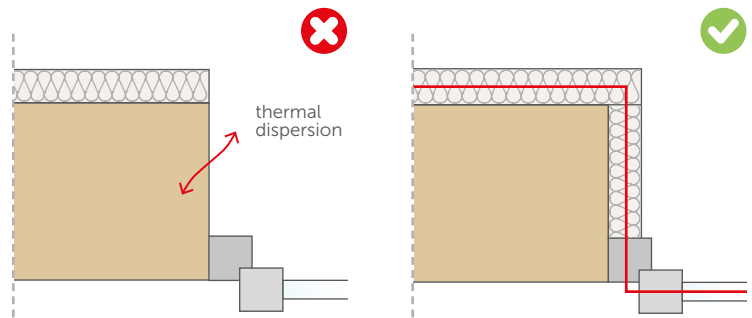

CENTRAL FLUSH INSTALLATION

It is the most common in traditional building systems. It is advisable to also insulate the side walls of the window hole in order to join them to the external insulation and avoid thermal bridges. For frame structures with an insulated gap, this solution is also suitable. The mechanical connection of the window/door is made directly to the load-bearing structure of the building.

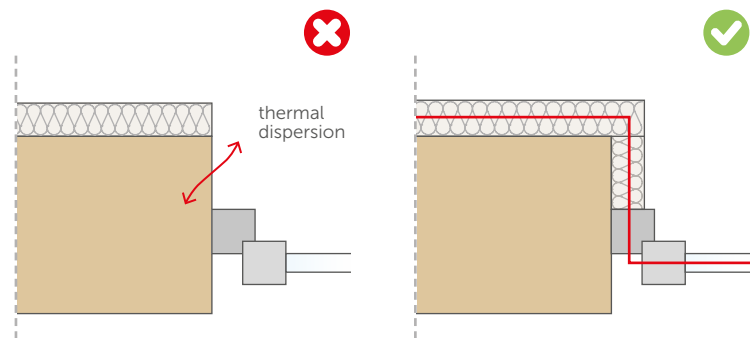

EXTERNAL FLUSH INSTALLATION

The external insulation must cover the fixed frame of the window/door and the subframe, if present, ensuring excellent internal surface temperatures. The mechanical connection of the window/door is made directly to the load-bearing structure of the building.

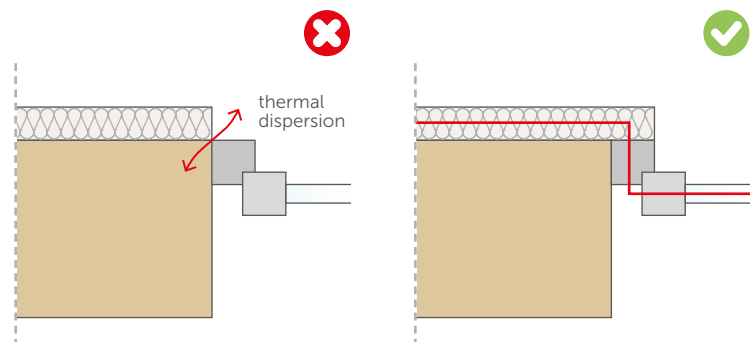

INSTALLATION IN THE INSULATION LAYER

This solution is adopted in the most high-performance constructions. It allows the reduction of the linear thermal bridge value. It requires more care when installing the window/door and greater insulation thickness.

The mechanical connection of the window/door frame to the structure can be made by means of an appropriately L or Z-shaped timber counterframe or by means of metal brackets. It is the configuration that allows for the best design of isothermal lines so as to avoid any thermal bridges.

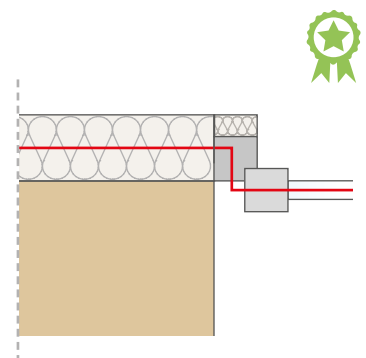

MASONRY STRUCTURE

INSTALLATION WITH FLUSH COUNTERFRAME

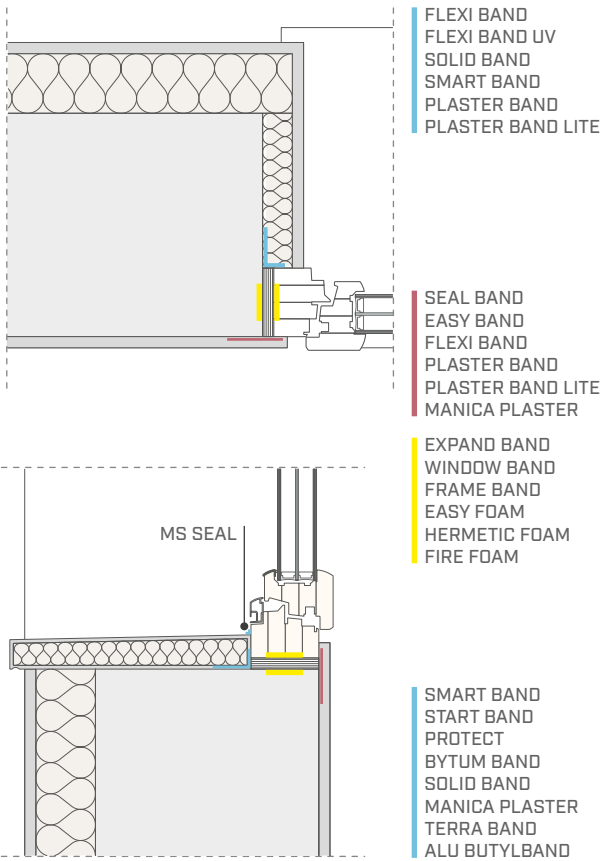

TIMBER FRAME STRUCTURE

INSTALLATION WITHOUT CENTRAL COUNTERFRAME

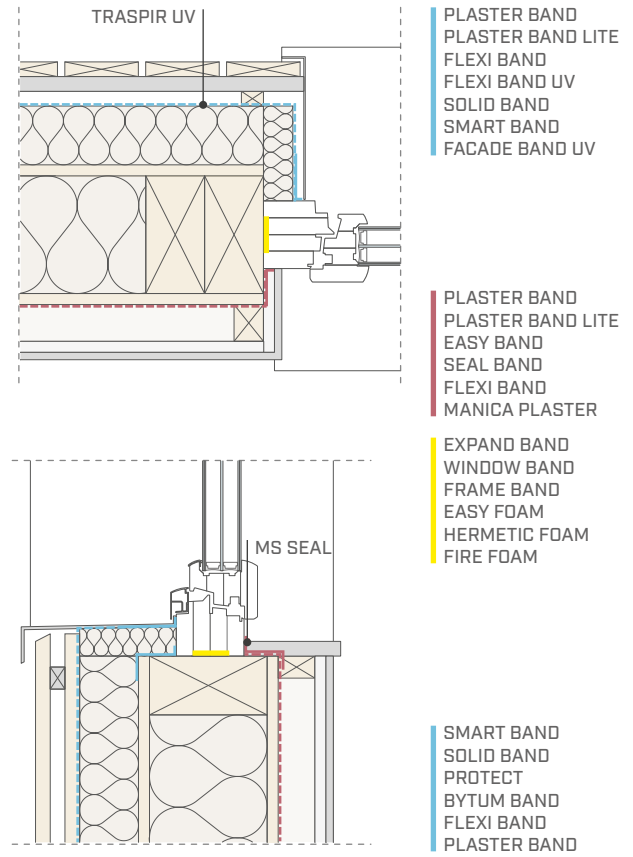

CLT STRUCTURE

INSTALLATION WITHOUT COUNTERFRAME FLUSH WITH THE OUTSIDE

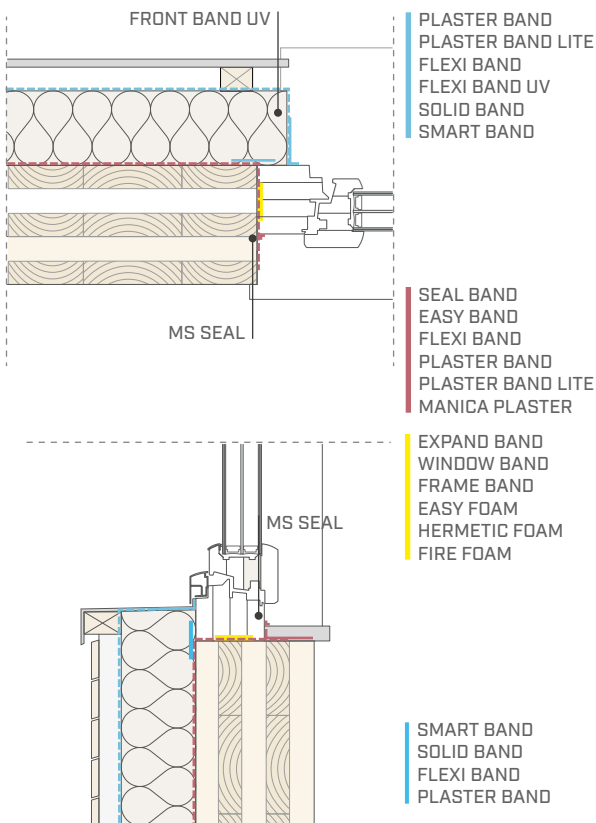

CLT STRUCTURE

INSTALLATION WITH COUNTERFRAME

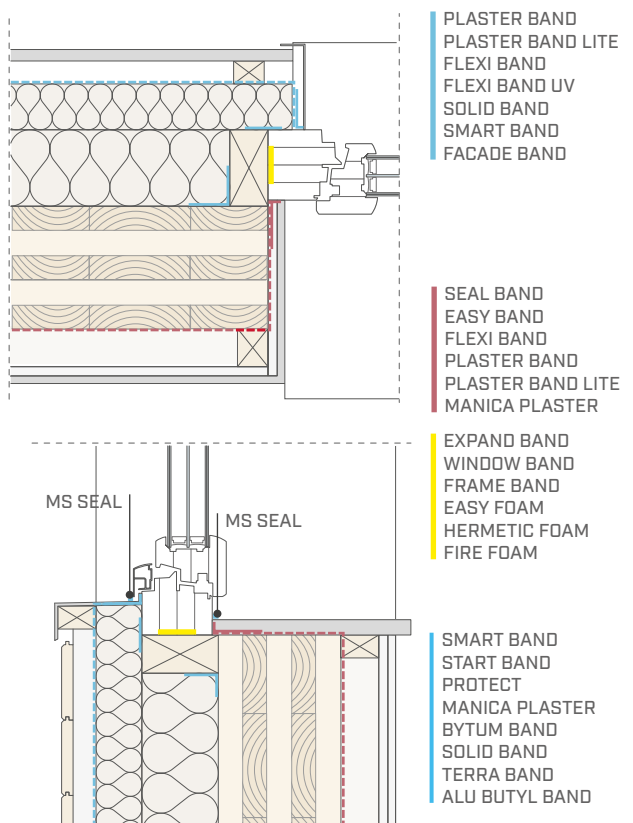

FIRE SEALING SILICONE

HIGH FIRE-RESISTANT SILICONE SEALANT
WITH ACOUSTIC PERFORMANCE



NOISE REDUCTION

The product was tested in different configurations at the University of Bologna according to C919-19 and ISO 10140-2:2021 achieving acoustic performance of up to 50 dB.

SAFETY

For sealing linear joints in fire rated walls and doors, in situations subject to fire regulations.

FIRE PROTECTION AND SOUNDPROOFING

FIRE SEALING SILICONE is a unique product as it provides maximum fire protection by achieving an EI240 with a B-s1,d0 fire rating.



CODES AND DIMENSIONS

CODE	content [ml]	content [US fl oz]	colour	version	
FIRESILGRE310	310	10.48	grey	rigid cartridge	24
FIRESILIVO310	310	10.48	ivory	rigid cartridge	24

TECHNICAL DATA

Properties	standard	value	USC conversion
Composition	-	silicone	-
Classification	EN 15651-1	F-EXT/INT-CC ⁽¹⁾	-
Density	ISO 1183-1	1,482 g/mL	237.65 oz/gal
Yield for 10x10 mm joint	-	3,1 m	10.7 ft
Surface cross-linking time 23 °C	-	approx. 80 min	-
Hardening speed 23 °C	-	approx. 2 mm in 24 h	-
Shore A hardness	DIN 53505	approx. 30	-
Elongation at failure	DIN 53504	460%	-
Tensile strength	DIN 53504	0,72 N/mm ²	104.43 lbf/in ²
Compressive modulus 100%	DIN 53504	0,38 N/mm ²	55.11 lbf/in ²
Reaction to fire	EN 13501-1	class B-s1,d0	-
Fire resistance rating	EN 13501-2	EI 240 ⁽²⁾	-
Acid resistance	-	excellent	-
Bases resistance	-	excellent	-
Emicode	GEV test procedure	EC1	-
French VOC classification	ISO 16000	A+	-
VOC content	-	4,3% / 64 g/L	-
Expiry ⁽³⁾	-	up to 12 months	-

⁽¹⁾ Non-structural sealant for façade elements, for external and internal use, also in areas with cold climates.

⁽²⁾ Valid for tested configurations.

⁽³⁾ Store the product in a dry place and check the expiry date on the cartridge.

Waste classification (2014/955/EU): 08 04 09.

Eye Dam. 1 . Skin Sens. 1B.

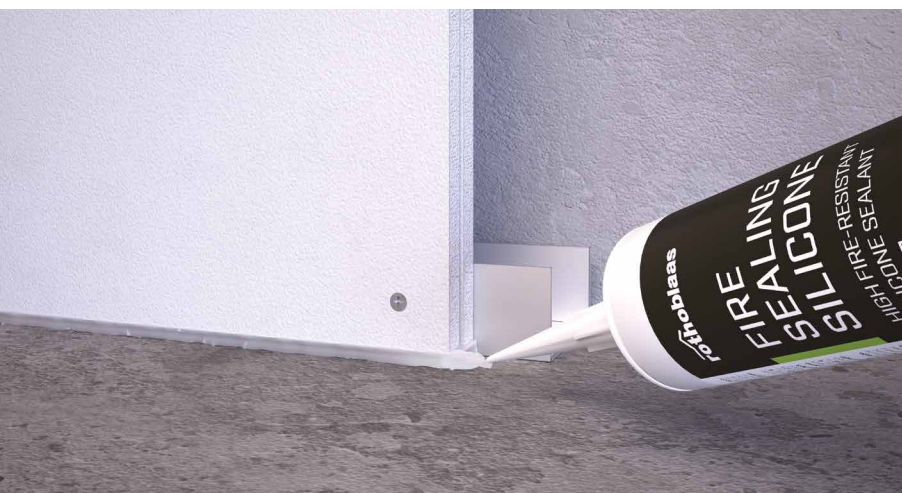

FIRE RESISTANCE EI 240 AND CLASS B-s1, d0

Tested protection, designed to offer maximum protection against the passage of flames, smoke or gases.

COLOURS

Thanks to its two colours, it can also be installed unobtrusively in sealing linear joints of walls and fire doors, in situations subject to fire regulations.

✓ FIRE SEALING SILICONE | Tests performed

SOUND REDUCTION INDEX LEVEL MEASUREMENTS

At the laboratories of the Building and Construction Research Centre - CIRI of the University of Bologna, tests were carried out according to ASTM C919 to characterise the sealant from an acoustic point of view. The application of silicone made it possible to restore the sound reduction index that the wall had lost when a crack was created in it.

plasterboard panels reaching down to the floor

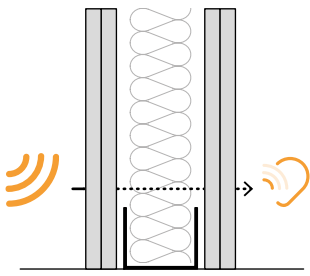

$$R_w (C;C_{tr}) = 50 (-2;-7) \text{ dB}$$

plasterboard panels that do not touch the floor

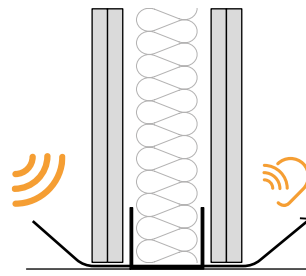

$$R_w (C;C_{tr}) = 25 (0;-2) \text{ dB}$$

plasterboard panels with **FIRE SEALING SILICONE** to restore sound reduction index

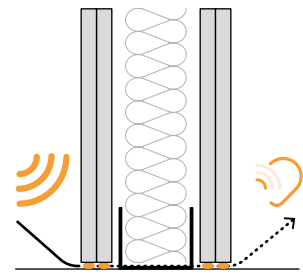

$$R_w (C;C_{tr}) = 49 (-2;-8) \text{ dB}$$

Use the QR-code to download the complete manual!

www.rothoblaas.com



FIRE STRIPE GRAPHITE A 10 CONNECTION!

In contact with fire, FIRE STRIPE GRAPHITE increases its volume 10 times and provides maximum protection in the event of fire. Thanks to its composition and the addition of graphite, it increases fire resistance on timber-to-steel connections and fire doors.

Scan the QR code and discover the technical features of waterproofing products



www.rothoblaas.com



rothoblaas

Solutions for Building Technology

MS SEAL

MS POLYMER HIGH ELASTICITY SEALANT



IT CAN BE PAINTED

It can be overpainted with water-based paints commonly used in construction.

SAFE

MS SEAL is pure, single-component, with practically no shrinkage, and offers an alternative for air-tightness in the case of visible sealing.



CODES AND DIMENSIONS

CODE	content		version	
	[ml]	<i>content</i> [US fl oz]		
MSSEALWHI300	300	10.15	rigid cartridge	24
MSSEALGRE300	300	10.15	rigid cartridge	24
MSSEALWHI600	600	20.29	soft cartridge	12
MSSEALGRE600	600	20.29	soft cartridge	12

TECHNICAL DATA

Properties	standard	value	USC conversion
Classification	EN 15651-1	F-EXT/INT-CC ⁽¹⁾	-
Specific weight	-	1,5 kg/dm ³	0.87 oz/in ³
Surface cross-linking time 20 °C / 50% RH	-	approx. 20 min	-
Hardening speed 20 °C / 50%RH	-	2,5 mm/24 h	0.1 in/24 h
Shore A hardness	DIN 53505	25	-
Elongation at failure	ISO 8339	400%	-
Elastic return	ISO 7389	> 70%	-
Application temperature	-	+5 / +35 °C	+41 / +95 °F
French VOC classification	ISO 16000	A+	-
VOC content	ISO 11890-2	9,2 g/L	-
Storage temperature ⁽²⁾	-	+5 / +25 °C	+41 / +77 °F

⁽¹⁾ Non-structural sealant for façade elements, for external and internal use, also in areas with cold climates.

⁽²⁾ Store the product in a dry and covered place (12 months rigid cartridge/18 months soft cartridge). Check the expiry date on the packaging.



PERFORMANCE

Excellent resistance to ageing and UV rays. Classified as a non-structural sealant for façade elements, for outdoor and indoor use, also in areas with cold climates (type F-EXT-INT-CC) according to EN 15651-1.

UNIVERSAL

Universal one-component sealant ideal for gluing and sealing the most common building materials.

HERMETIC FOAM

HIGH PERFORMING SOUNDPROOFING SEALING FOAM



CERTIFIED NOISE REDUCTION

Up to 63 dB noise reduction, certified by the IFT Rosenheim institution (ISO 10140-1).

AIRTIGHT EVEN AFTER TRIMMING

Waterproof and airtight, even if trimmed after hardening, thanks to the closed-cell structure.



CODES AND DIMENSIONS

CODE	content	yield	content	yield	cartridge	
	[ml]	[L]	[US fl oz]	[US gal]		
HERFOAM	750	40	25.36	10.57	aluminium	12
HERFOAMB2	750	32	25.36	8.45	aluminium	12

TECHNICAL DATA

HERFOAM

Properties	standard	value	USC conversion
Composition	-	Single component PU	-
Colour	-	white	-
Film formation time 23 °C / 50% RH	-	6 - 10 min	-
Cutting time 23 °C / 50% RH	-	20 - 40 min	-
Time required for complete hardening 23 °C / 50% RH	-	60 min	-
Thermal conductivity (λ)	FEICA TM1020/ EN 12667	0,030 - 0,035 W/(m·K)	0.017 - 0.02 BTU/h·ft·°F
Acoustic insulation of joints R _{s,w} (ift)	EN ISO 10140-1	10 mm: ≥ 63 (-1;-5) dB	-
	EN ISO 10140-2 EN ISO 717-1	20 mm: ≥ 62 (-1;-5) dB	-
Water vapour resistance factor (μ)	EN 12086	36	-
Reaction to fire	DIN 4102-1	class B3	-
	EN 13501-1	class F	-
Temperature resistance once hardened	-	-40 / +90 °C	-40 / +194 °F
Application temperature (cartridge, environment and support)	-	+5 / +35 °C	+41 / +95 °F
Emicode	GEV test procedure	EC1 plus	-
French VOC classification	ISO 16000	A+	-
VOC content	-	17,0 % - 173,3 g/L	-
Transport temperature	-	0 / +35 °C	+32 / +95 °F
Storage temperature ⁽¹⁾	-	+15 / +25 °C	+59 / +77 °F
Storage time ⁽²⁾	-	12 months	-

⁽¹⁾Store the product in a vertical position in a dry, covered location.

⁽²⁾Check the expiry date on the cartridge.

Waste classification (2014/955/EU): 16 05 04.

Aerosol 1. Acute Tox. 4. Acute Tox. 4. Skin Irrit. 2. Eye Irrit. 2. Resp. Sens. 1. Skin Sens. 1. Carc. 2. STOT SE 3. STOT RE 2

TECHNICAL DATA

HERFDAMB2

Properties	standard	value	USC conversion
Composition	-	Single component PU	-
Colour	-	white	-
Density	-	15-20 kg/m ³	-
Film formation time 20°C / 65% RH	-	6-8 min	-
Cutting time 23 °C / 50% RH	-	15-20 min	-
Reaction to fire	EN 13501-1 DIN 4102-1	class E class B2	- -
Temperature resistance once hardened	-	-40 / +80 °C	-40 / +176 °F
Application temperature (cartridge)	-	+5 / +35 °C	+41 / +95 °F
Application temperature (ambient)	-	+5 / +35 °C	+41 / +95 °F
Application temperature (support)	-	+5 / +35 °C	+41 / +95 °F
Storage temperature ⁽¹⁾	-	+15 / +25 °C	+59 / +77 °F
Storage time ⁽²⁾	-	12 months	-

⁽¹⁾Store the product in a vertical position in a dry, covered location.

⁽²⁾Check the expiry date on the cartridge.

FIELDS OF APPLICATION

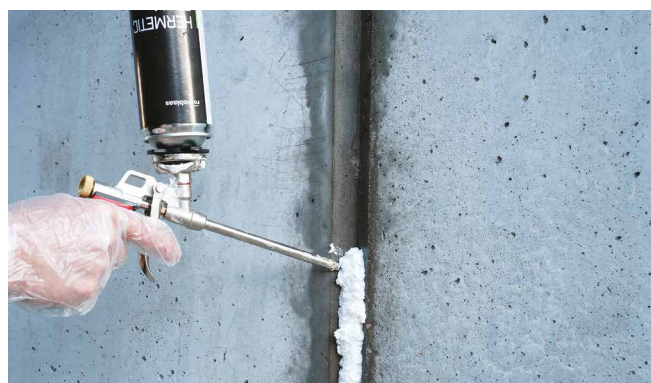
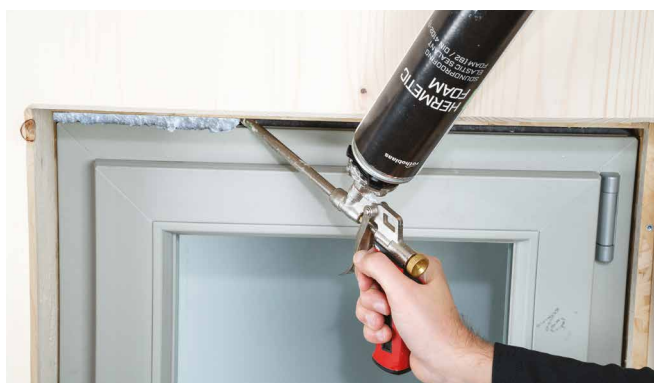

RELATED PRODUCTS



FLY FOAM



FOAM CLEANER



MARLIN

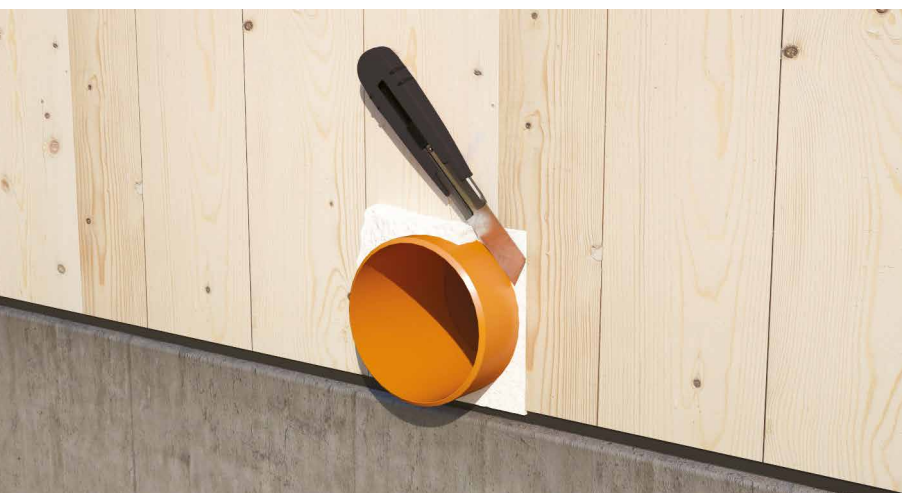

EMICODE EC1 PLUS

Its low VOC content and very low emissions also make this foam perfect for indoor use.

HIGH ELASTICITY

Thanks to its composition, it remains elastic and deformable over time, compensating for the movements of the wood and differential deformation of the building materials.

EXPAND BAND

SELF-EXPANDING SEALING TAPE

D
DIN 18542
BG 1

PERMANENT ELASTIC EXPANSION

The tape self-expansion remains elastic and unchanged over time, providing protection from water, dust and wind.

SAFETY

The modified polyurethane foam has passed the most stringent tests on harmful emissions, ensuring safe installation even indoors.

COMPOSITION

EXPAND BAND

elastic polyurethane foam with additives

release liner
silicone coated paper

EXPAND BAND EVO

elastic polyurethane foam with special film additives



CODES AND DIMENSIONS

EXPAND BAND

CODE	B			L	B			L	
	[mm]	s	[mm]		[in]	s	[mil]		
EXPAND1014	10	1	4	13	0.4	39	157	43	48
EXPAND1514	15	1	4	13	0.6	39	157	43	32
EXPAND1549	15	4	9	8	0.6	157	354	26	32
EXPAND15615	15	6	15	6	0.6	236	591	20	32
EXPAND20920	20	9	20	4	0.8	354	787	13	24
EXPAND40615	40	6	15	8	1.6	236	591	26	12
EXPAND60615	60	6	15	8	2.4	236	591	26	8

EXPAND BAND EVO

CODE	B			L	B			L	
	[mm]	s	[mm]		[in]	s	[mil]		
EXPANDEVO1514	15	1	4	13	0.6	39	157	43	32

TECHNICAL DATA

Properties	standard	value	USC conversion
Classification	DIN 18542	BG 1	-
Airtightness	EN 12114	$\alpha \leq 1,0 \text{ m}^3/(\text{h}\cdot\text{m}\cdot(\text{daPa})^n)$	-
Tightness in heavy rain	EN 1027	$\geq 750 \text{ Pa}$	-
Resistance to UV and weathering	DIN 18542	compliant with class BG 1	-
Compatibility with other building materials	DIN 18542	compliant with class BG 1	-
Water vapour transmission (Sd)	EN ISO 12572	< 0,5 m	-
Reaction to fire	DIN 4102-1	class B1	-
Thermal conductivity (λ)	EN 12667	$\leq 0,043 \text{ W}/(\text{m}\cdot\text{K})$	$\leq 0.025 \text{ BTU}/\text{h}\cdot\text{ft}\cdot^\circ\text{F}$
Temperature resistance	-	-30 / +90 °C	-22 / +194 °F
Application temperature	-	$\geq +5 \text{ °C}$	$\geq +41 \text{ °F}$
Storage temperature ⁽¹⁾	-	+1 / +20 °C	+33.8 / +68 °F

⁽¹⁾Store the product in a dry, covered location for no more than 24 months.
Waste classification (2014/955/EU): 17 02 03.

FIELDS OF APPLICATION

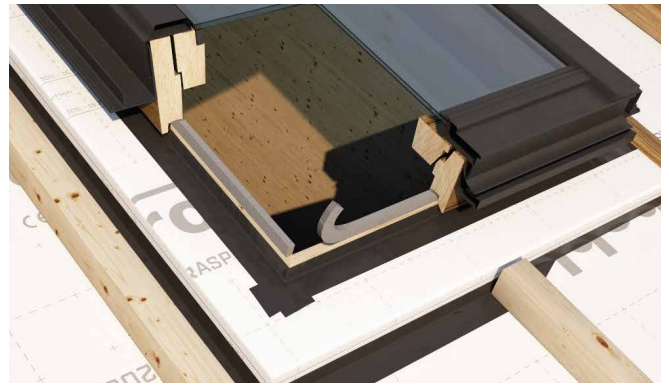

RELATED PRODUCTS



MARLIN



WINBAG



KOMPRI CLAMP



EVO VERSION

The EVO version not only reduces waste and installation time because it has no separating layer, but also has a special film that keeps its shape without self-expanding as long as it is rolled up.

SAFE PACKAGING

Supplied with a plastic core to prevent water and moisture absorption during construction, which could cause unwanted swelling.

WINDOW BAND

SELF-EXPANDING SEALING TAPE FOR WINDOWS/DOORS



TRIPLE PROTECTION

It seals the joints of doors and windows from air and heavy rain while maintaining the thermal-acoustic properties over the entire depth.

SELF-EXPANDING

Seals cracks between 6 and 15 mm, adjusting to the surface, and also ensures air and water tightness, serving as a vapour control layer.

COMPOSITION

elastic polyurethane foam with additives



CODES AND DIMENSIONS

CODE	B			s			L			
	[mm]	[mm]	[mm]	[mm]	[mm]	[mm]	[mm]	[mm]		
WINDOW54615	54	6	15	15	2.1	236	591	49	7	
WINDOW74615	74	6	15	15	2.9	236	591	49	5	

TECHNICAL DATA

Properties	standard	value	USC conversion
Classification	DIN 18542	BG 1 ⁽¹⁾	-
Airtightness	EN 12114	$\alpha \leq 1.0 \text{ m}^3/(\text{h}\cdot\text{m}\cdot(\text{daPa})^n)$	-
Tightness in heavy rain	EN 1027	$\geq 600 \text{ Pa}$	-
Resistance to UV and weathering	DIN 18542	compliant with class BG 1	-
Compatibility with other building materials	DIN 18542	compliant with class BG 1	-
Water vapour resistance factor (μ)	EN ISO 12572	< 100	-
Vapour pressure gradient	-	externally permeable	-
Reaction to fire	DIN 4102-1	class B1	-
Acoustic insulation of the joint	-	59 dB	-
Thermal conductivity (λ)	EN 12667	$\leq 0,043 \text{ W}/(\text{m}\cdot\text{K})$	$\leq 0.025 \text{ BTU}/\text{h}\cdot\text{ft}\cdot^\circ\text{F}$
Temperature resistance	-	$-30 / +90 \text{ }^\circ\text{C}$	$-22 / +194 \text{ }^\circ\text{F}$
Application temperature	-	$\geq +5 \text{ }^\circ\text{C}$	$\geq +41 \text{ }^\circ\text{F}$
Storage temperature ⁽²⁾	-	$+1 / +20 \text{ }^\circ\text{C}$	$+33.8 / +68 \text{ }^\circ\text{F}$

⁽¹⁾BG 1: in accordance with DIN 18542, BG 1 tapes are suitable for outdoor use even when exposed to UV light and are watertight under a pressure of at least 600 Pa.

⁽²⁾Store the product in a dry, covered location for no more than 24 months.

■ FIELDS OF APPLICATION



■ RELATED PRODUCTS



MARLIN



WINBAG



KOMPRI CLAMP



FAST INSTALLATION

The advantage of WINDOW BAND is that it saves a considerable amount of time during assembly. With just one product it is possible to seal the three layers without the need for other.

PERFORMING BG1

Compliant with EnEV and RAL requirements, also guarantees a high level of thermal and acoustic insulation.

PLASTER BAND IN/OUT

SPECIAL HIGH-ADHESION TAPE, CAN BE ALSO PLASTERED

EXCELLENT ADHESION

Its excellent adhesion makes it ideal for application on most surfaces, even at low temperatures.

RESISTANT SEPARATION FILM

Even when applied in tight spaces and corners, the PP liner can be removed without risk of failure.



CODES AND DIMENSIONS

PLASTER BAND IN

CODE	liner [mm]	B [mm]	t [mm]	T [mm]	L [m]	liner [in]	B [in]	L [ft]	
1 PLASTIN1560	15 / 60	75	-	75	25	0.6 / 2.4	3.0	82	5
1 PLASTIN1585	15 / 85	100	-	100	25	0.6 / 3.4	4.0	82	4
1 PLASTIN15135	15 / 135	150	-	150	25	0.6 / 5.3	5.9	82	2
2 PLASTIN7520	75	75	20	75	25	3.0	3.0	82	5
2 PLASTIN10020	100	100	20	100	25	3.9	3.9	82	4
2 PLASTIN15020	150	150	20	150	25	5.9	5.9	82	2

PLASTER BAND OUT

CODE	liner [mm]	B [mm]	t [mm]	T [mm]	L [m]	liner [in]	B [in]	L [ft]	
1 PLASTOUT1560	15 / 60	75	-	75	25	0.6 / 2.4	3.0	82	5
1 PLASTOUT1585	15 / 88	100	-	100	25	0.6 / 3.4	4.0	82	4
1 PLASTOUT15135	15 / 135	150	-	150	25	0.6 / 5.3	5.9	82	2
1 PLASTOUT15185	15 / 185	200	-	200	25	0.6 / 7.3	7.9	82	2
2 PLASTOUT7520	75	75	20	75	25	3.0	3.0	82	5
2 PLASTOUT10020	100	100	20	100	25	3.9	3.9	82	4
2 PLASTOUT15020	150	150	20	150	25	5.9	5.9	82	2
2 PLASTOUT20020	200	200	20	200	25	7.9	7.9	82	2



■ FIELDS OF APPLICATION

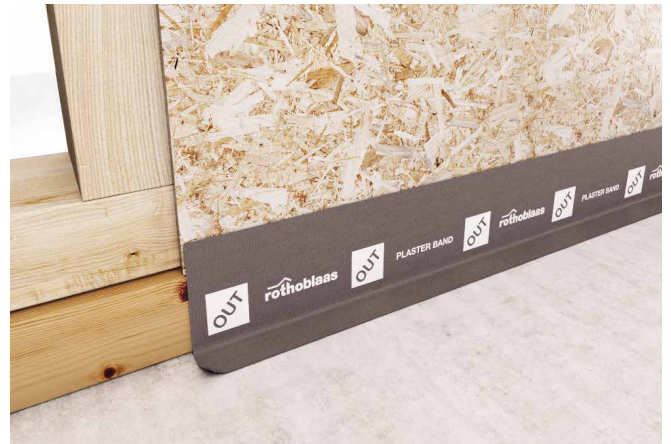

■ RELATED PRODUCTS



WINDOW BAND



EXPAND BAND



HERMETIC FOAM



MANICA PLASTER

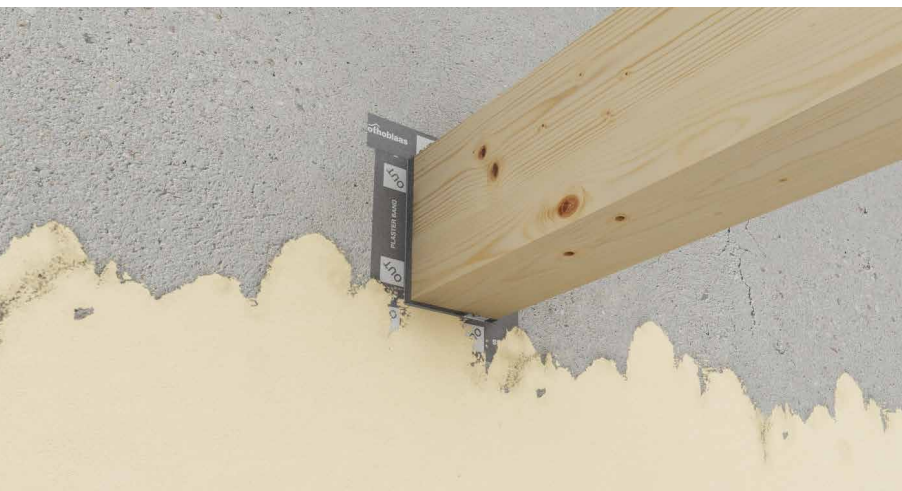

CAN BE PLASTERED

Technical fabric ideal to be plastered after its application. The pre-cut liner allows for quick and easy installation and a high level of aesthetics due to the possibility of concealing the tape behind claddings or plaster.

EASY-RELEASE FILM

The easy-release PP liner provides a quick and easy installation.

PLASTER BAND IN

COMPOSITION

- support
2-layer PP vapour control membrane
- adhesive
acrylic dispersion without solvents
- release liner
easy-release PP film

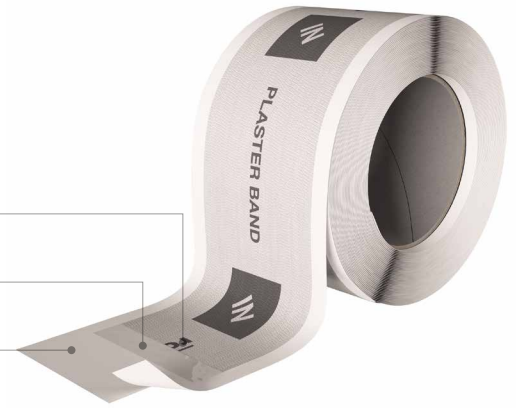

COMPOSITION

- support
2-layer PP vapour control membrane
- adhesive
acrylic dispersion without solvents
- release liner
easy-release PP film

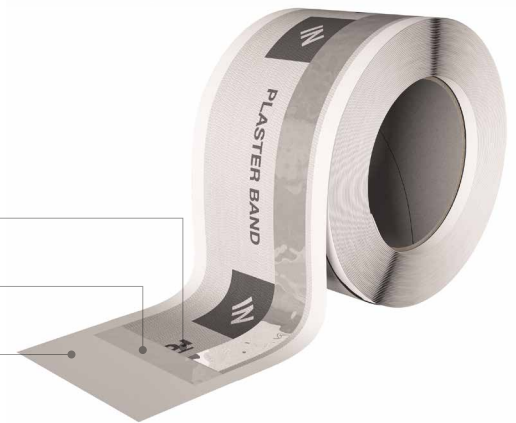

TECHNICAL DATA

Properties	standard	value	USC conversion
Total thickness	DIN 53855	0,5 mm	20 mil
Mass per unit area	EN 1848-2	300 g/m ²	113.9 oz/ft ²
Water vapour transmission (Sd)	EN 1931	> 10 m	< 0.35 US perm
Tensile strength MD/CD	EN 12311-1	115 / 75 N/50 mm	13.13/8.57 lbf/in
Elongation MD/CD	EN 12311-1	75 / 80%	-
Watertightness	EN 13984	W1	-
Tightness in heavy rain	EN 1027	≥ 1050 Pa	-
Air permeability	EN 1026	≤ 0,1 m ³ /(h·m·(daPa) ^{2/3}	-
UV-resistant	-	3 months	-
Reaction to fire	EN 13501-1	class E	-
Application temperature	-	> +5 °C	> +41 °F
Temperature resistance	-	-40 / +80 °C	-40 / +176 °F
Storage temperature ⁽¹⁾	-	+5 / +25 °C	+41 / +77 °F
Solvents	-	no	-
Emicode	GEV test method	EC1 plus	-

⁽¹⁾Store the product in a dry, covered location for no more than 24 months.

PLASTER BAND OUT

COMPOSITION

- support
breathable 2-layer PP membrane
- adhesive
acrylic dispersion without solvents
- release liner
easy-release PP film

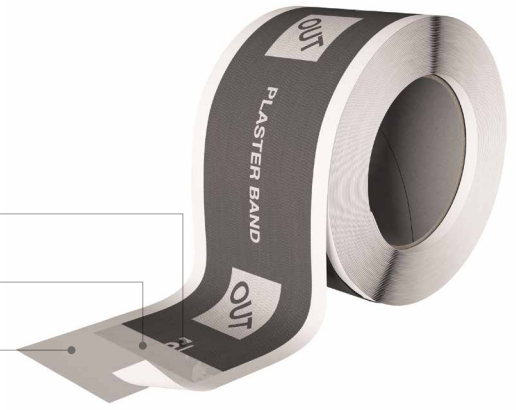

COMPOSITION

- support
breathable 2-layer PP membrane
- adhesive
acrylic dispersion without solvents
- release liner
easy-release PP film

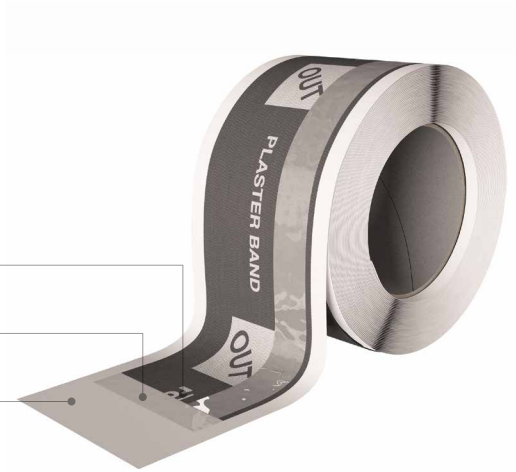

TECHNICAL DATA

Properties	standard	value	USC conversion
Total thickness	DIN 53855	0,7 mm	28 mil
Mass per unit area	EN 1848-2	360 g/m ²	-
Water vapour transmission (Sd)	EN 1931	< 1 m	> 3.5 US perm
Tensile strength MD/CD	EN 12311-1	290 / 190 N/50 mm	-
Elongation MD/CD	EN 12311-1	75 / 135%	-
Watertightness	EN 13984	W1	-
Tightness in heavy rain	EN 1027	≥ 1050 Pa	-
Air permeability	EN 1026	≤ 0,1 m ³ /(h·m·(daPa) ^{2/3}	-
UV-resistant	-	12 months	-
Reaction to fire	EN 13501-1	class E	-
Application temperature	-	> -10 °C	> +14 °F
Temperature resistance	-	-40 / +80 °C	-40 / +176 °F
Storage temperature ⁽¹⁾	-	+5 / +25 °C	+41 / +77 °F
Solvents	-	no	-
Ecode	GEV test method	EC1 plus	-

⁽¹⁾Store the product in a dry, covered location for no more than 24 months.

PLASTER BAND IN | Recommendations for installation

APPLICATION OF THE TAPE BEFORE INSTALLATION OF THE WINDOW/DOOR FRAME

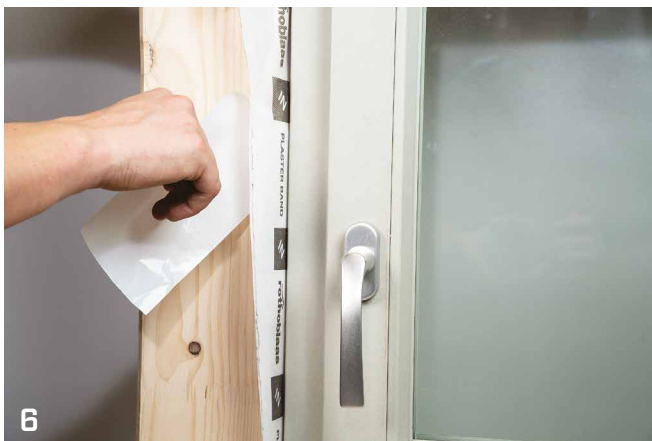
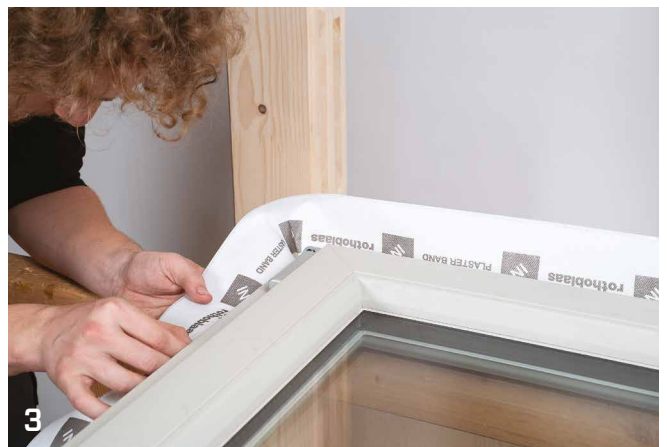
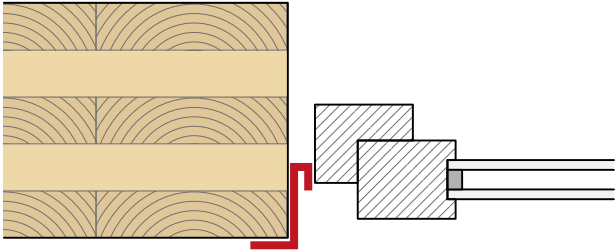

SEALING WITH WINDOW/DOOR ALREADY INSTALLED

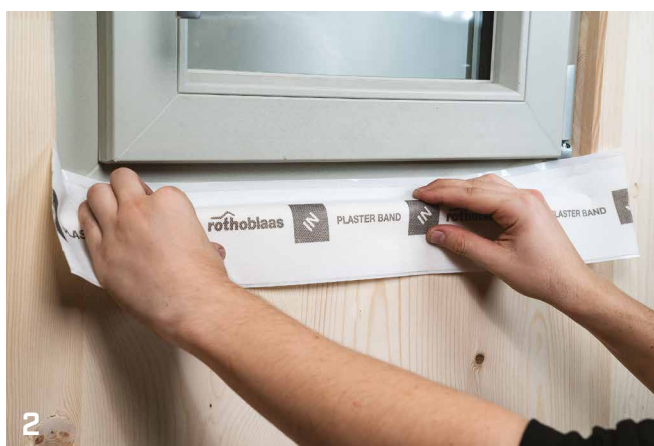
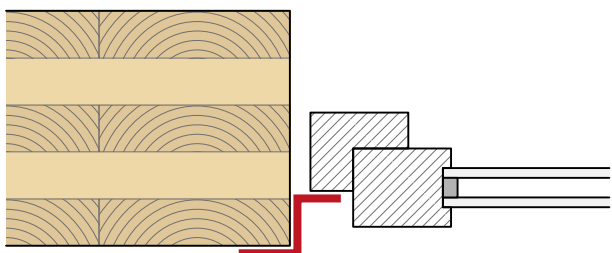

PLASTER BAND OUT | Recommendations for installation

APPLICATION OF THE TAPE BEFORE INSTALLATION OF THE WINDOW/DOOR FRAME

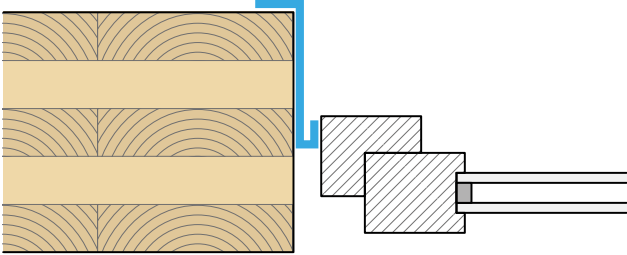

SEALING WITH WINDOW/DOOR ALREADY INSTALLED

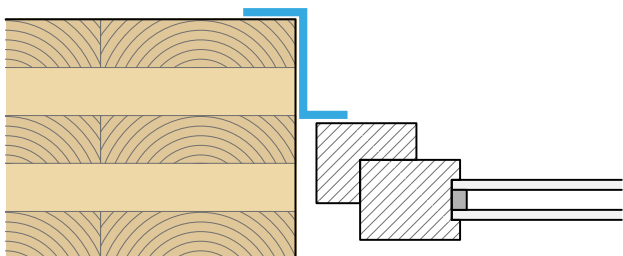

SMART BAND

UNIVERSAL SINGLE-SIDED TAPE WITH SEPARABLE LINER

SPECIAL LINER

The product has a unique separating film which, thanks to a special treatment, can be divided at any point without pre-cutting, thus adapting to any installation requirement.

FLASHING TAPE

It meets all the requirements to be classified as a tape for sealing external doors or windows, ensuring maximum safety even in case of stagnating water.

COMPOSITION

- support
PE special film

- support
UV-stabilised PE film

- glue
acrylic dispersion without solvents

- release liner
PP film with easy splitting

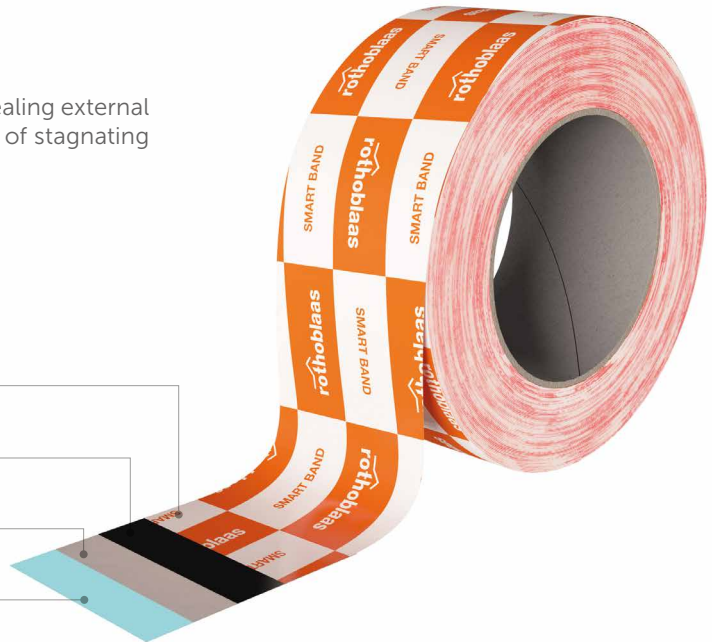

CODES AND DIMENSIONS

CODE	B	L	B	L	
	[mm]	[m]	[in]	[ft]	
SMART60	60	25	2.4	82	10
SMART75	75	25	3.0	82	8
SMART100	100	25	3.9	82	6
SMART150	150	25	5.9	82	4
SMART225	225	25	8.9	82	2
SMART300	300	25	11.8	82	2

TECHNICAL DATA

Properties	standard	value	USC conversion
Thickness	-	0,24 mm	9.5 mil
Adhesion to OSB	ASTM D3330	≥ 5 N/10mm	≥ 2.86 lbf/in
Adhesion to steel	ASTM D3330	≥ 12 N/10mm	≥ 6.85 lbf/in
Adhesion to vinyl	ASTM D3330	≥ 5 N/10mm	≥ 2.86 lbf/in
Adhesion to plywood	ASTM D3330	≥ 5 N/10mm	≥ 2.86 lbf/in
Adhesion to its cladding material	ASTM D3330	≥ 10 N/10mm	≥ 5.71.86 lbf/in
Tensile strength	ASTM D 1000	3000 N/mm	17.13 lbf/mil
Elongation at failure	ASTM D 1000	≥ 400 %	-
Water vapour transmission (Sd)	-	> 18 m	< 0.19 US perm
UV-resistant	-	12 months	-
Tightness in heavy rain	-	conforming	-
Application temperature	-	-10 / +40 °C	+14 / +104 °F
Temperature resistance	-	-30 / +80 °C	-22 / +176 °F
Storage temperature	-	+5 / +30 °C	+41 / +86 °F

In order to measure adhesion, it was necessary to avoid stretching by applying another tape to the support.

■ FIELDS OF APPLICATION



■ PRODUCT RANGE



SMART60



SMART75



SMART100



SMART150



SMART225

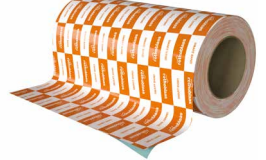

SMART300



PUNCTURE RESISTANT

The special composition of the support makes it particularly resistant to tearing and mechanical stress, thanks to its high deformability.

SMART

The tape is unique and extremely versatile. Thanks to the easy-splitting liner, only a few sizes can be stored to meet any construction requirement.

SMART BAND | Recommendations for installation

WINDOW HOLE SEALING

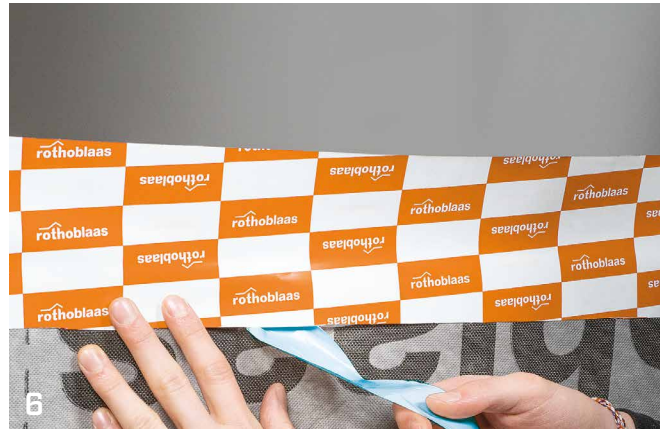

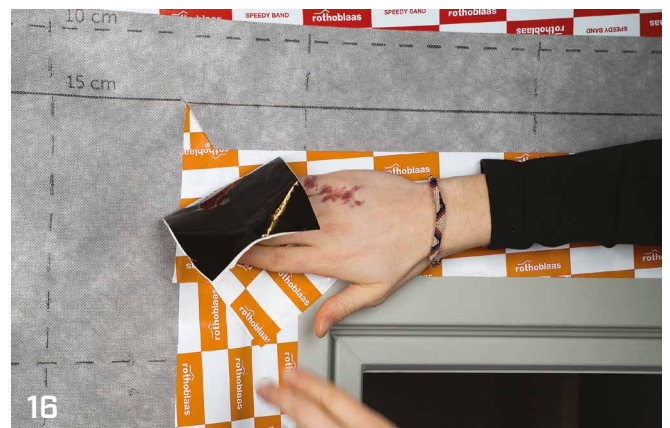

Rotho Blaas Srl does not guarantee the legal and/or design conformity of data and calculations, as Rotho Blaas provides indicative tools such as technical-commercial service within the sales activity.

Rotho Blaas Srl follows a policy of continuous development of its products, thereby reserving the right to modify their characteristics, technical specifications and other documentation without notice.

The user or the designer are responsible to verify, at each use, the conformity of the data to the regulations in force and to the project. The ultimate responsibility for choosing the appropriate product for a specific application lies with the user/designer.

The values resulting from "experimental investigations" are based on the actual test results and valid only for the test conditions specified.

Rotho Blaas Srl does not guarantee and in no case can be held responsible for damages, losses and costs or other consequences, for any reason (warranty for defects, warranty for malfunction, product or legal responsibility, etc.) deriving from the use or inability to use the products for any purpose; from non-conforming use of the product;

Rotho Blaas Srl is not liable in any way for any errors in printing and/or typing. In the event of differences between the contents of the catalogue versions in the various languages, the Italian text is binding and takes precedence with respect to the translations.

Pictures are partially completed with accessories not included. Images are for illustration purposes only. Packaged quantities may vary.

This catalogue is private property of Rotho Blaas Srl and may not be copied, reproduced or published, totally or in part, without prior written consent. All violations will be prosecuted according to law.

The general purchase conditions of Rotho Blaas Srl are available on the website www.rothoblaas.com.

LEGEND

A	[m ²]	area
B	[mm]	base
H	[mm] [m]	height
L	[mm] [m]	length
P	[mm]	depth
s	[mm]	thickness
Ø	[mm]	diameter

VOC Volatile Organic Compounds



Environmental Product Declaration



Life Cycle Assessment



reaction to fire



gloves included in the box



tested according to ASTM standards



classification GEV - EMICODE



classification according to French decree no. 2011-321

- FASTENING
- AIRTIGHTNESS AND WATERPROOFING
- SOUNDPROOFING
- FALL PROTECTION
- TOOLS AND MACHINES

Rothoblaas is the multinational Italian company that has made innovative technology its mission, making its way to the forefront for timber buildings and construction safety in just a few years. Thanks to its comprehensive product range and the technically-prepared and widespread sales network, the company promotes the transfer of its know-how to the customers and aims to be a prominent and reliable partner for developing and innovating products and building methods. All of this contributes to a new culture of sustainable construction, focused on increasing comfortable living and reducing CO₂ emissions.

Rotho Blaas Srl

Via dell'Adige N.2/1 | 39040, Cortaccia (BZ) | Italia
Tel: +39 0471 81 84 00 | Fax: +39 0471 81 84 84
info@rothoblaas.com | www.rothoblaas.com



01SOUND3EN 12/22



8 059386 072127

