

ROOFS AND ROOFING

Safety, durability and maintenance



 **rothoblaas**

Solutions for Building Technology

VERTICAL NET

VERTICAL POLYPROPYLENE FALL PROTECTION SAFETY NET

Protection system for roof edges and scaffolding.

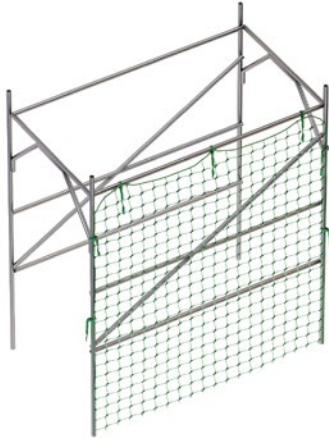

FRAME NET

FALL PROTECTION SAFETY NET WITH FRAME

Ideal for securing the roof when there is no possibility of installing external scaffolding or perimeter protection with external fastening.



TEMPORARY RAILING BARRIERS

EDGE TEMP 1

TEMPORARY RAILING ROOF SIDE



EDGE TEMP 4

TEMPORARY UNIVERSAL RAILING WITH STEM



PERMANENT RAILING BARRIERS

GUARD V/GUARD VD

RAILING VERTICAL AND VERTICAL SPACED FASTENING

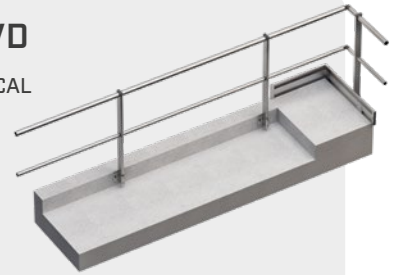

GUARD M

RAILING FASTENING ON TRAPEZOIDAL METAL ROOF

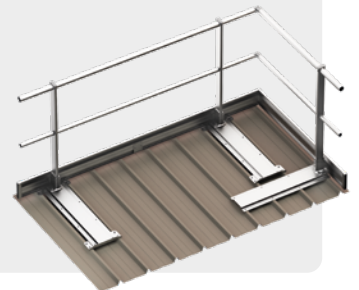

LADDER HOOKS

HANG TEMP

MOBILE LADDER HOOK

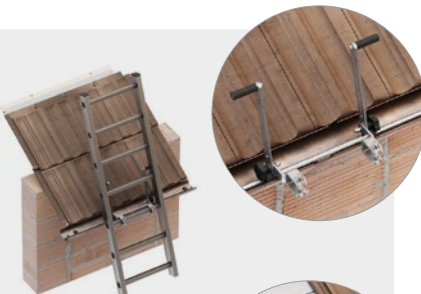

HANG ROOF

LADDER HOOK FOR PITCHED ROOFS



LADDERS

LADSTEP

CAGED LADDERS



HORIZONTAL NET

HORIZONTAL POLYPROPYLENE FALL PROTECTION SAFETY NET

Possibility of joining several nets together using HORCONNECT sewing rope to cover larger areas.



GREEN LINE

LIFE LINE ON SUPPORTS WITH BALLAST

System with reduced visual impact, almost invisible once installed.



PATROL + TOWER / TOWER A2

LIFELINE ON SUPPORT FOR TIMBER, CONCRETE AND STEEL ROOFS



PATROL + SHIELD / SHIELD 2.0

LIFELINE ON SUPPORT FOR TRAPEZOIDAL METAL ROOFS WITH AND WITHOUT INSULATION LAYER



HOOK SPIKE

ANCHOR POINT WITH LADDER HOOK



LOOP

ANCHOR POINT



SIANK

ANCHOR POINT FOR STANDING SEAM METAL ROOFS



WING

ANCHOR POINT

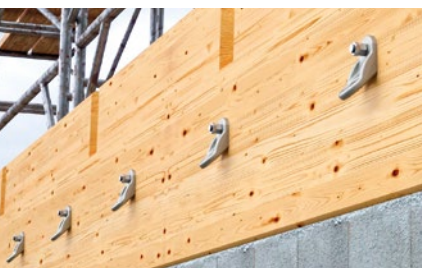

KITE

ANCHOR POINT



AOS

ANCHOR POINT



TRASPIR | TRASPIR EVO

HIGHLY BREATHABLE MEMBRANE

COMPLETE RANGE

Waterproof, it allows the passage of vapour.
EVO versions with monolithic film.
Mass per unit area from 95 to 430 g/m².



TRASPIR EVO UV

HIGHLY BREATHABLE MONOLITHIC MEMBRANE
RESISTANT TO UV RAYS

B-s1,d0

Flame retardant certification, Euroclass reaction to fire B-s1,d0 based on EN 13501-1.



TRASPIR METAL

3D MATS FOR METAL ROOFS

CERTIFIED NOISE REDUCTION

The 3D mats guarantee reduction of airborne and heavy rain noises. Values tested and certified.

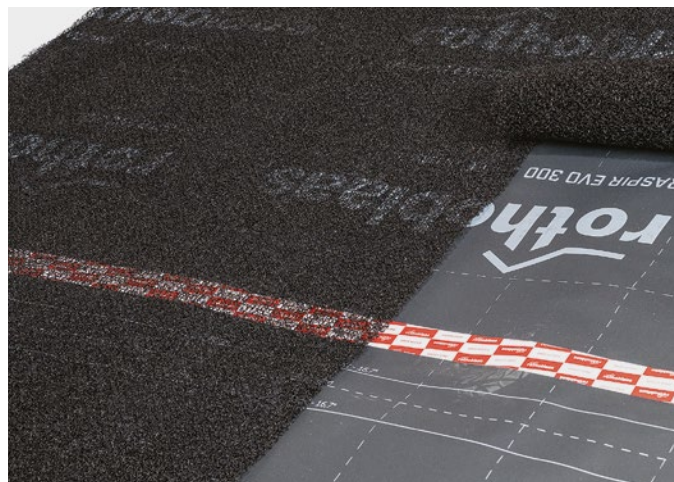

CAP TOP

TARPAULIN FOR ROOFS

During construction, it offers temporary protection against rain and avoids infiltration of dust and construction remains into the cracks between the panels.



FLEXI BAND

UNIVERSAL SINGLE-SIDED
HIGH-ADHESIVE TAPE



See also:

ROLLER

ROLLER FOR TAPES



SPEEDY BAND

UNIVERSAL SINGLE-SIDED TAPE
WITHOUT RELEASE LINER



See also:

SPEEDY ROLL

SPEEDY BAND UNWINDER
WITH LONG HANDLE



FACADE BAND UV

UNIVERSAL SINGLE-SIDED TAPE,
RESISTANT TO UV RAYS



See also:

CUTTER

FOR PROFESSIONAL CUTTING



PRIMER SPRAY

UNIVERSAL SPRAY PRIMER FOR
ACRYLIC ADHESIVE TAPES

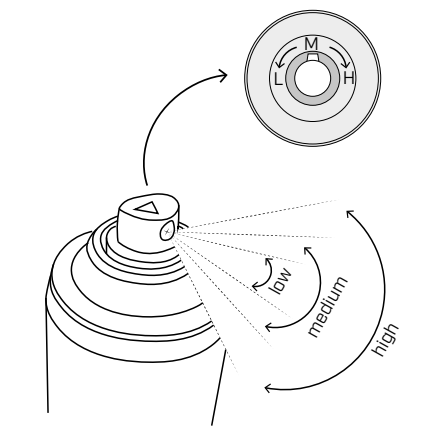

NAIL PLASTER

HIGH-ADHESION NAIL POINT
SEALANT TAPE



See also:

LIZARD

UNWINDER FOR NAIL POINT
SEALING TAPE

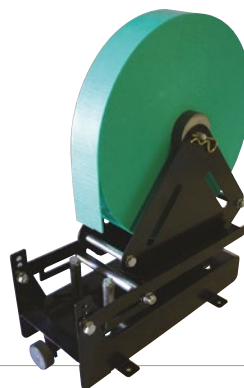

OUTSIDE GLUE

HIGH ELASTICITY UNIVERSAL ADHESIVE
GLUE FOR EXTERNAL USE



See also:

FLY / FLY SOFT

PROFESSIONAL GUNS FOR 310 ml CARTRIDGES
AND FOR 600 ml SOFT CARTRIDGES



EASY FOAM

GENERAL PURPOSE FOAM SEALANT

Compatibility for indoor use tested and certified by EC1 plus.



FLY FOAM

AUTOMATIC LONG TUBE GUN FOR FOAMS

- For all common bayonet lock foam cartridges
- With screw for flow regulation



FLUID MEMBRANE

SYNTHETIC SEALING MEMBRANE FOR BRUSH AND SPRAY APPLICATION

The synthetic resin mix is elastic and resistant to any movement of the sealed cracks



MANICA FLEX

SEALING SLEEVE FOR CONDUIT AND CABLE PASSAGE



MANICA POST

ADHESIVE SEALING SLEEVE FOR OUTDOORS



BLACK BAND

UNIVERSAL SINGLE-SIDED BUTYL TAPE



BYTUM

BYTUM SPRAY

BITUMINOUS MEMBRANE SEALANT SPRAY



BYTUM LIQUID

SPREADABLE WATERPROOFING SHEATH

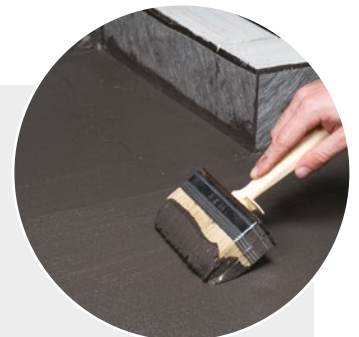

BYTUM BASE 2500

SELF-ADHESIVE BITUMINOUS MEMBRANE



BYTUM SLATE 3500

SELF-ADHESIVE SLATED BITUMINOUS MEMBRANE

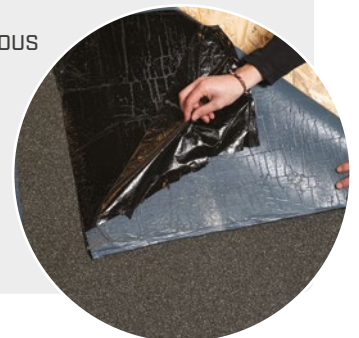

VENTILATION AND PROTECTION

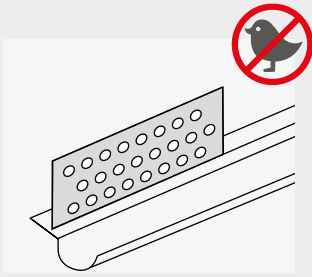

Protect air inlets and outlets from insects and birds, minimising section obstruction.

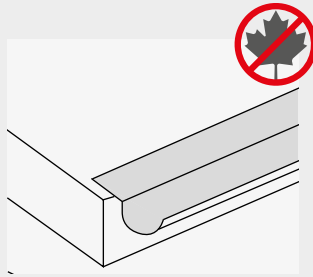

Check that the gutter and ridge are free of obstacles that could impede air circulation.

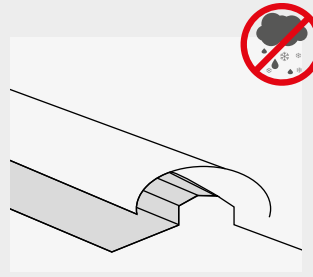

Ensure water and snow transported by the wind near the ridge is sealed out.

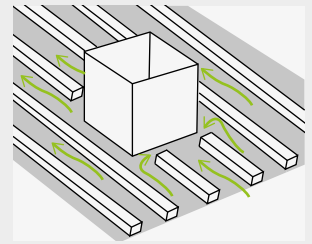

Avoid battening or other impediments that could block the upward flow of air heated along the slope.

SUPPORT BATTEN

METAL BATTEN-HOLDERS



NET ROLL

FLEXIBLE VENTILATED UNDER-RIDGE



SOFT FLASH CONNECT

EPDM AND BUTYL SELF-ADHESIVE VERSION



BIRD SPIKE

RIGID BIRD SPIKES



BIRD COMB

STANDARD EAVES BIRD COMBS

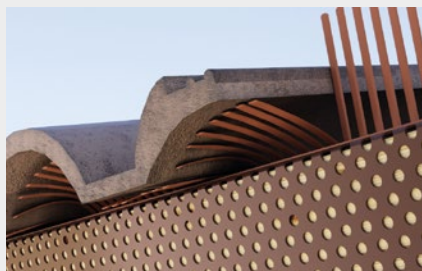

SNOW STOP

SNOW STOPPER HOOK FOR RIDGE TILES AND TILES



VENT FOLD

PRE-BENT GRID FOR VENTILATION

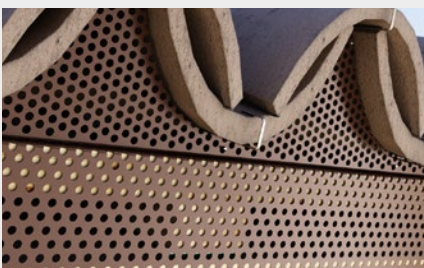

VENT SHAPE

SHAPED VENTILATION GRID FOR ROOFS MADE OF RIDGE TILES AND TILES



RAIN TUBE

TEMPORARY DOWNPIPE FOR CONSTRUCTION SITE PHASES



KMR 3516

ROOFING NAILGUN 16°

- With regulator penetration
- Nail length: **19 - 45 mm**
- Ø head: **10,5 mm**
- Weight: **1,8 kg**



KMR 3590

COIL NAILGUN 20°

- Pull-through adjustment does not require the use of tools
- Nail length: **60 - 90 mm**
- Ø nail: **2,8 - 3,4 mm**
- Weight: **3,2 kg**



KMR 3535

STRIP MAGAZINE NAILGUN 20°

- With keeper against blank firing
- Nail length: **80 - 130 mm**
- Ø nail: **3,1 - 4,2 mm**
- Weight: **6,4 kg**



KMR 3822

ANKER 34° NAILGUN

- Cordless - gas operated
- Nail length: **40 - 60 mm**
- Ø nail: **4,0 mm**
- Weight: **3,6 kg**



KMR 3482

STAPLER FOR STAPLES K

- Staple type / length: **K 6 - 16 mm**
- Weight: **0,9 kg**



BOUND NAILS

SMOOTH, RING, ROLL, STRIP



MULE

TEMPORARY MATERIALS CANOPY, CAN BE USED AS BEARING OR WORKING SURFACE

Used in pairs, it works as a support for battens, roof tiles, tools, machines and more.

Thanks to the 8 possible adjustments, it adapts to roofs with an inclination from 15° to 60°.

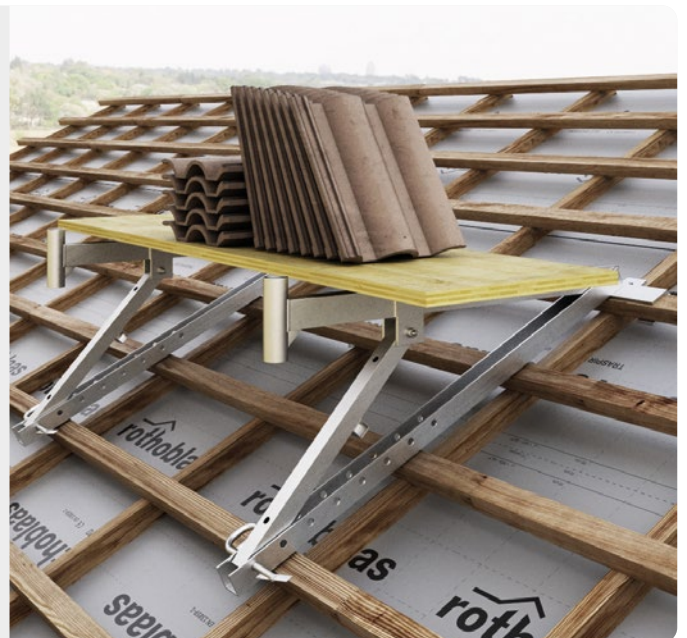

KMR 3373

LOADER FOR SCREWDRIVERS

- With metric thread M5
- Screw length: **25 - 50 mm**
- Screw diameter: **3,5 - 4,2 mm**
- Compatible with Mafell A 18 M bl cordless screwdriver
- Weight: **0,80 kg**

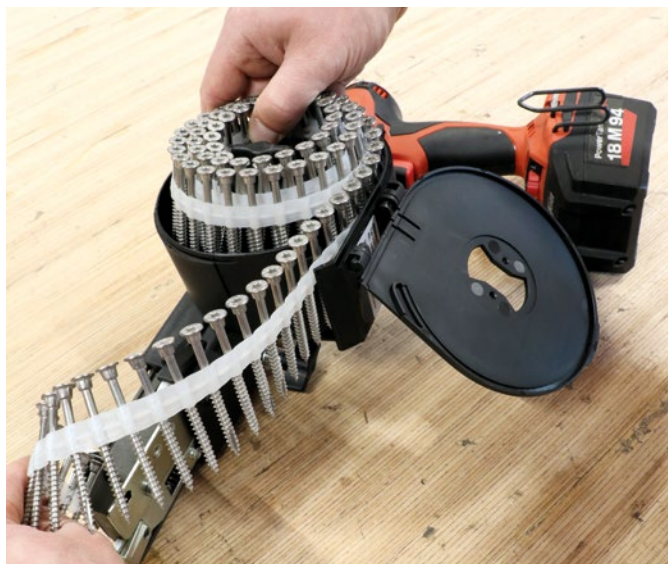

KMR 3352

SCREWDRIVER WITH AUTOMATIC LOADER

- Screw length: **25 - 50 mm**
- Screw diameter: **3,5 - 4,2 mm**
- Power: **750 W**
- No load speed: **0 - 2850 U/min**
- Weight: **2,2 kg**



HBS COIL

HBS BOUND SCREWS

- Quick and precise fastening. Fast and safe execution thanks to the special binding.
- Also available in a diameter of 6,0 mm, ideal for quick wall-to-wall fastening in CLT structures

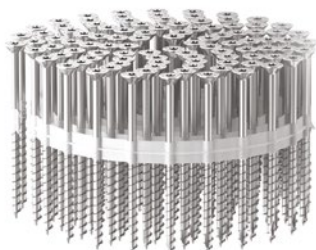

LBA STRIP

ELECTROGALVANIZED HIGH BOND NAIL WITH BINDING

- High-bond, threaded annular ring nail for improved pull-out strength.
- It has CE marking in accordance with ETA for fastening metal plates onto timber structures. It is also available in A4 | AISI316 stainless steel for outdoor applications.

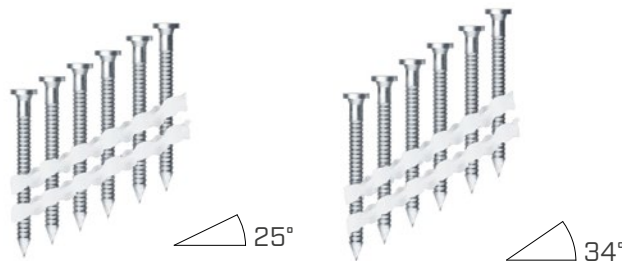

TOOLS AND MACHINES, everything you need to work in best conditions on site. Discover them on our website or ask your trusted agent for the catalogue. www.rothoblaas.com



HBS

COUNTERSUNK SCREW



TBS EVO

FLANGE HEAD SCREW

C4
EVO
COATING



DGZ

DOUBLE THREADED SCREW
FOR INSULATION LAYER



LAMA

KNIFE FOR INSULATION MATERIAL



MCS A2 | AISI304

SCREW WITH WASHER FOR METAL SHEET

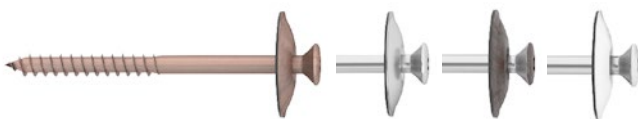

MTS A2 | AISI304

SCREWS FOR METAL SHEET



Discover the complete range of **FASTENING** on our website
or request the catalogue from your trusted agent.
www.rothoblaas.com

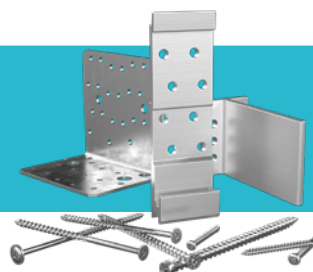

INA

5.8 STEEL CLASS THREADED ROD
FOR CHEMICAL ANCHORS



VIN-FIX

VINYL ESTER CHEMICAL ANCHOR WITHOUT
STYRENE

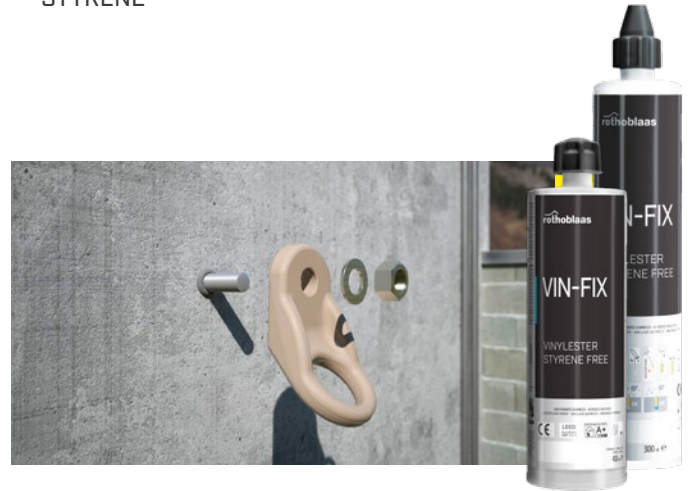

LBB

PERFORATED STRAP

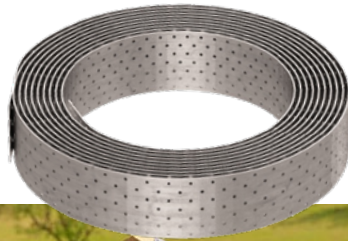

WKF

ANGLE BRACKETS FOR FACADES



WBAZ

STAINLESS STEEL WASHER WITH
SEALING GASKET



NINO

UNIVERSAL ANGLE BRACKET FOR
SHEAR AND TENSILE LOADS

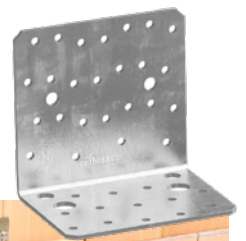

To keep up to date with the world of timber construction and fall protection systems, discover the **ROTHOSCHOOL** courses.
www.rothoblaas.com/school



PERSONAL PROTECTIVE EQUIPMENT

HELMETS

Line of helmets for work at height, on construction site or in industrial areas. Adjustable and ready to assemble head lamps and other accessories.

HARNESSES

Semiprofessional and professional harnesses for fall protection, positioning and rope access work.

ROPES AND CONNECTORS

Abrasion resistant work ropes featuring great handling, to be combined with connectors available in a wide range of shapes, sizes and breaking strengths.



Rotho Blaas Srl

Via dell'Adige N.2/1 | 39040, Cortaccia (BZ) | Italia
Tel: +39 0471 81 84 00 | Fax: +39 0471 81 84 84
info@rothoblaas.com | www.rothoblaas.com

